



EASTLIKE LED Co., Ltd

CATALOG

LED Lighting Series

Green Low Carbon Energy Saving

10. Ground & Garden



www.eastlike.com



公司簡介 Company Profile



製造和營銷綠色低碳節能照明產品
Manufacturing And Marketing Green Low Carbon
And Energy Saving Lighting Products

EASTLIKE LED COMPANY 東 櫛 照 明 公 司

EASTLIKE LED Co., Ltd • emerges as a lighting designer, manufacturer and supplier established in Hong Kong and Mainland China .

The company devotes herself in the development, manufacturing and marketing of green, low-carbon and energy-saving lighting products. we are proud to provide a wide range of LED products

東櫛LED照明公司•您的照明設計師。

我們作為製造商和供應服務於香港和中國大陸。公司致力於開發，製造和行銷綠色，
低碳和節能照明產品。

我們竭誠為您服務，為您提供種類繁多的LED產品。

目录

Content



P.01

橢圓款明裝防水燈



P.02

橢圓款明裝防水燈



P.03

圓款明裝防水燈



P.04

圓款明裝防水燈



P.05

LED戶外嵌入式地埋燈



P.06

LED戶外嵌入式地埋燈



P.07

LED戶外嵌入式地埋燈



P.08

LED戶外嵌入式地埋燈

Oval Surface Mounted Waterproof Lamp

Series Type: ECBWL1C

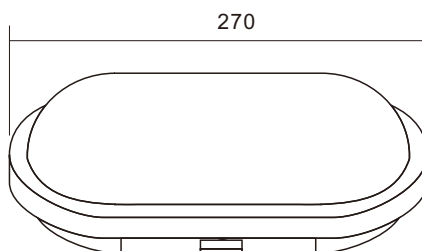
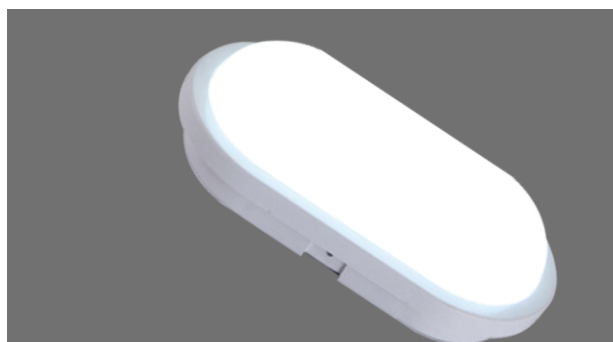

(Unit : mm)

Features 產品特點

- ★ Rainproof and insect proof
- ★ Integrated design
- ★ IP65 waterproof function

- ★ 防雨防蟲
- ★ 一體化設計
- ★ IP65防水功能

Specification 產品規格

Model 型號	Voltage 電壓	Wattage 功率	Size 尺寸	Lamp Life 光度壽命	Colour Temp 色溫	Lumen Output 輸出流明	Color Rendering 顯色度	Beam Angle 發光角度	Operating Temperature 工作溫度
	(V)	(W)	(mm)	(Hrs)	(K)	(Lm/W)	(CRI)	(°)	(°C)
EWL-1022-E	85-265	22	270*140*60	30,000	6000	80	80	120	-20~45

Light efficiency (lm/W), Power (W), Color Rendering Index (CRI), Can be customized according to customer needs.

Our Standard Power factor (PF) > 0.9 and Total harmonic index THD < 15%, According to customer requirements can produce a lower THD < 10%.

This type of certification is issued by a government-approved laboratory for Safety certification, Fire testing, Restriction of Hazardous Substances (RoHS), Photobiological safety of lamps and lamp systems. (an Exemption Group) and other test certifications to ensure product quality

光效 (lm/W)、功率 (W)、顯色指數 (CRI)，可根據客戶需求定制。

此型號標準之功率因素 (PF) > 0.9，總諧波指數 THD < 15%，可按客戶需要生產低總諧波指數 < 10%。

此型號認證由可實驗室發出之安全認證消防測試，環保物料 (RoHS)，光生物安全為 Exemption Group 及其它測試，保證客戶使用更安心滿意。

Oval Surface Mounted Waterproof Lamp

Series Type: ECBWL80

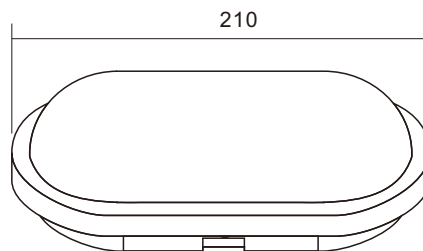

(Unit : mm)

Features 產品特點

- ★ Rainproof and insect proof
- ★ Integrated design
- ★ IP65 waterproof function

- ★ 防雨防蟲
- ★ 一體化設計
- ★ IP65防水功能

Specification 產品規格

Model 型號	Voltage 電壓	Wattage 功率	Size 尺寸	Lamp Life 光度壽命	Colour Temp 色溫	Lumen Output 輸出流明	Color Rendering 顯色度	Beam Angle 發光角度	Operating Temperature 工作溫度
	(V)	(W)	(mm)	(Hrs)	(K)	(Lm/W)	(CRI)	(°)	(°C)
EWL-0815-E	85-265	15	210*100*60	30,000	6000	80	80	100	-20~45

Light efficiency (lm/W), Power (W), Color Rendering Index (CRI), Can be customized according to customer needs.

Our Standard Power factor (PF) > 0.9 and Total harmonic index THD < 15%, According to customer requirements can produce a lower THD < 10%.

This type of certification is issued by a government-approved laboratory for Safety certification, Fire testing, Restriction of Hazardous Substances (RoHS), Photobiological safety of lamps and lamp systems. (an Exemption Group) and other test certifications to ensure product quality

光效 (lm/W)、功率 (W)、顯色指數 (CRI), 可根據客戶需求定制。

此型號標準之功率因素 (PF) > 0.9, 總諧波指數 THD < 15%, 可按客戶需要生產低總諧波指數 < 10%。

此型號認證由可實驗室發出之安全認證消防測試, 環保物料 (RoHS), 光生物安全為 Exemption Group 及其它測試, 保證客戶使用更安心滿意。

Round Surface Mounted Waterproof Lamp

Series Type: ECBWN85

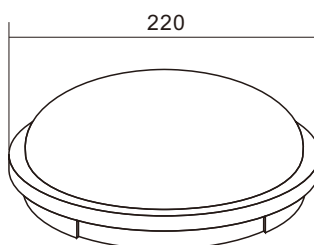
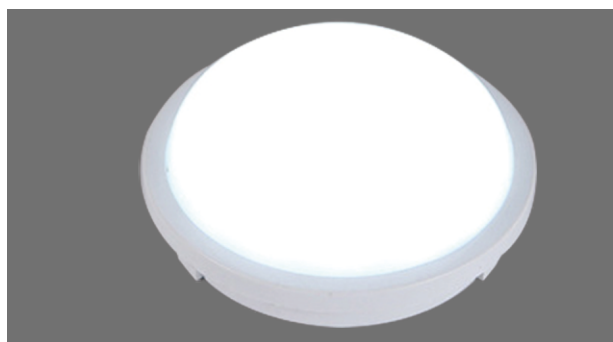

(Unit : mm)

Features 產品特點

- ★ Rainproof and insect proof
- ★ Integrated design
- ★ IP65 waterproof function

- ★ 防雨防蟲
- ★ 一體化設計
- ★ IP65防水功能

Specification 產品規格

Model 型號	Voltage 電壓	Wattage 功率	Size 尺寸	Lamp Life 光度壽命	Colour Temp 色溫	Lumen Output 輸出流明	Color Rendering 顯色度	Beam Angle 發光角度	Operating Temperature 工作溫度
	(V)	(W)	(mm)	(Hrs)	(K)	(Lm/W)	(CRI)	(°)	(°C)
EWL-0822-C	85-265	22	220*60	30,000	6000	80	80	120	-20~45

Light efficiency (lm/W), Power (W), Color Rendering Index (CRI), Can be customized according to customer needs.

Our Standard Power factor (PF) > 0.9 and Total harmonic index THD < 15%, According to customer requirements can produce a lower THD < 10%.

This type of certification is issued by a government-approved laboratory for Safety certification, Fire testing, Restriction of Hazardous Substances (RoHS), Photobiological safety of lamps and lamp systems. (an Exemption Group) and other test certifications to ensure product quality

光效 (lm/W)、功率 (W)、顯色指數 (CRI)，可根據客戶需求定制。

此型號標準之功率因素 (PF) > 0.9，總諧波指數 THD < 15%，可按客戶需要生產低總諧波指數 < 10%。

此型號認證由可實驗室發出之安全認證消防測試，環保物料 (RoHS)，光生物安全為 Exemption Group 及其它測試，保證客戶使用更安心滿意。

Round Surface Mounted Waterproof Lamp

Series Type: ECBWN65

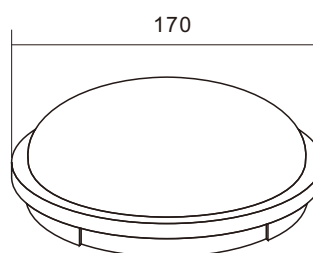
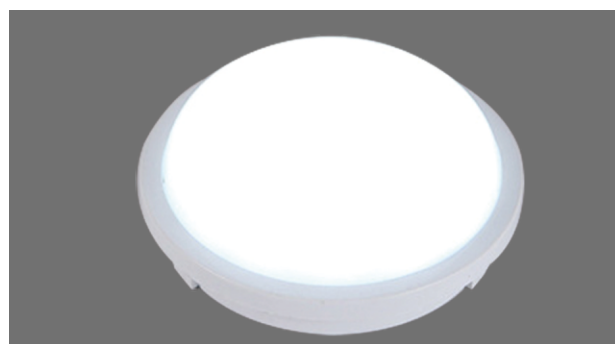

(Unit : mm)

Features 產品特點

- ★ Rainproof and insect proof
- ★ Integrated design
- ★ IP65 waterproof function

- ★ 防雨防蟲
- ★ 一體化設計
- ★ IP65防水功能

Specification 產品規格

Model 型號	Voltage 電壓	Wattage 功率	Size 尺寸	Lamp Life 光度壽命	Colour Temp 色溫	Lumen Output 輸出流明	Color Rendering 顯色度	Beam Angle 發光角度	Operating Temperature 工作溫度
	(V)	(W)	(mm)	(Hrs)	(K)	(Lm/W)	(CRI)	(°)	(°C)
EWL-0815-C	85-265	15	170*60	30,000	6000	80	80	120	-20~45

Light efficiency (lm/W), Power (W), Color Rendering Index (CRI), Can be customized according to customer needs.

Our Standard Power factor (PF) > 0.9 and Total harmonic index THD < 15%, According to customer requirements can produce a lower THD < 10%.

This type of certification is issued by a government-approved laboratory for Safety certification, Fire testing, Restriction of Hazardous Substances (RoHS), Photobiological safety of lamps and lamp systems. (an Exemption Group) and other test certifications to ensure product quality

光效 (lm/W)、功率 (W)、顯色指數 (CRI)，可根據客戶需求定制。

此型號標準之功率因素 (PF) > 0.9，總諧波指數 THD < 15%，可按客戶需要生產低總諧波指數 < 10%。

此型號認證由可實驗室發出之安全認證消防測試，環保物料 (RoHS)，光生物安全為 Exemption Group 及其它測試，保證客戶使用更安心滿意。

LED Outdoor Embedded Buried Lamp

Series Type: ECBE045

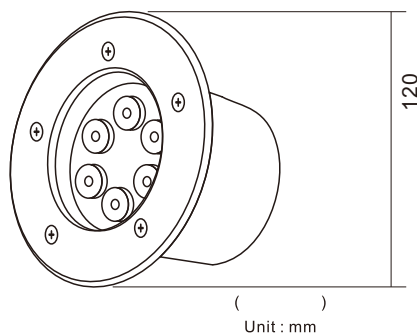
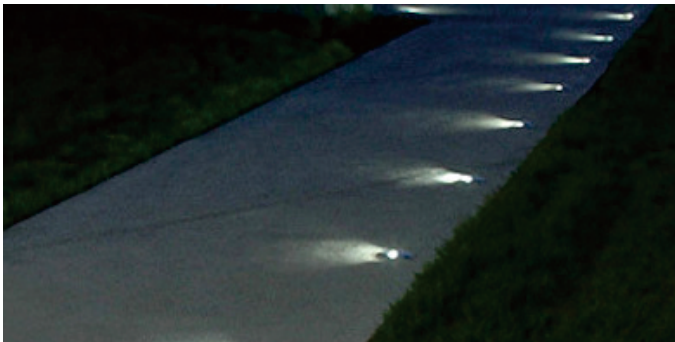

Features 產品特點

- ★ The lamp body is made of integrally molded aluminum, with strong rigidity, fast heat dissipation, corrosion resistance and oxidation resistance.
- ★ The cover is made of 304 stainless steel, with wear resistance, corrosion resistance and strong rigidity.
- ★ The lampshade adopts transparent toughened glass, which has no yellowing, light transmission, abrasion resistance, rigidity and anti-aging.
- ★ High brightness LED lamp beads are adopted, with high luminous efficiency, less heating, long service life and low energy consumption.
- ★ The LED lamp board is made with waterproof glue filling process + glass lampshade and waterproof silicone sealing secondary waterproof process to ensure the safe use of the lamp outdoors.

- ★ 燈體採用一體成型出模的鋁材，剛性強、散熱快、耐腐蝕、抗氧化。
- ★ 面蓋採用304不銹鋼材質，耐磨損、抗腐蝕、剛性強。
- ★ 燈罩採用透明鋼化玻璃，不發黃、透光強、耐磨損、剛性強、抗老化。
- ★ 採用高亮度LED燈珠，光效高、發熱少、壽命長、能耗低。
- ★ LED燈板做了防水灌膠工藝+玻璃燈罩和防水矽膠密封二次防水工藝，保障燈在戶外的安全使用,IP65防水功能。

Specification 產品規格

Model 型號	Voltage 電壓	Wattage 功率	Size 尺寸	Lamp Life 光度壽命	Colour Temp 色溫	Lumen Output 輸出流明	Color Rendering 顯色度	Beam Angle 發光角度	Operating Temperature 工作溫度
	(V)	(W)	(mm)	(Hrs)	(K)	(Lm/W)	(CRI)	(°)	(°C)
EGB-0506	85-265	6	120*90	5000	3000	80	80	90	-20~45

Light efficiency (lm/W), Power (W), Color Rendering Index (CRI), Can be customized according to customer needs.

Our Standard Power factor (PF) > 0.9 and Total harmonic index THD < 15%, According to customer requirements can produce a lower THD < 10%.

This type of certification is issued by a government-approved laboratory for Safety certification, Fire testing, Restriction of Hazardous Substances (RoHS), Photobiological safety of lamps and lamp systems. (an Exemption Group) and other test certifications to ensure product quality

光效 (lm/W)、功率 (W)、顯色指數 (CRI)，可根據客戶需求定制。

此型號標準之功率因素 (PF) > 0.9，總諧波指數 THD < 15%，可按客戶需要生產低總諧波指數 < 10%。

此型號認證由可實驗室發出之安全認證消防測試，環保物料 (RoHS)，光生物安全為 Exemption Group 及其它測試，保證客戶使用更安心滿意。

LED Outdoor Embedded Buried Lamp

Series Type: ECBE060

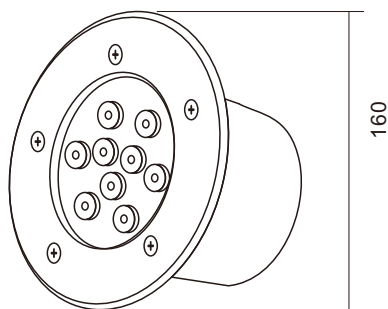
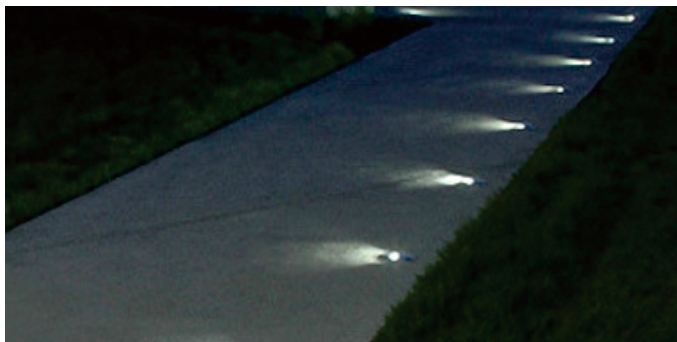

(Unit : mm)

Features 產品特點

- ★ The lamp body is made of integrally molded aluminum, with strong rigidity, fast heat dissipation, corrosion resistance and oxidation resistance.
 - ★ The cover is made of 304 stainless steel, with wear resistance, corrosion resistance and strong rigidity.
 - ★ The lampshade adopts transparent toughened glass, which has no yellowing, light transmission, abrasion resistance, rigidity and anti-aging.
 - ★ High brightness LED lamp beads are adopted, with high luminous efficiency, less heating, long service life and low energy consumption.
 - ★ The LED lamp board is made with waterproof glue filling process + glass lampshade and waterproof silicone sealing secondary waterproof process to ensure the safe use of the lamp outdoors.
- ★ 燈體採用一體成型出模的鋁材，剛性強、散熱快、耐腐蝕、抗氧化。
 - ★ 面蓋採用304不銹鋼材質，耐磨損、抗腐蝕、剛性強。
 - ★ 燈罩採用透明鋼化玻璃，不發黃、透光強、耐磨損、剛性強、抗老化。
 - ★ 採用高亮度LED燈珠，光效高、發熱少、壽命長、能耗低。
 - ★ LED燈板做了防水灌膠工藝+玻璃燈罩和防水矽膠密封二次防水工藝，保障燈在戶外的安全使用,IP67防水功能。

Specification 產品規格

Model 型號	Voltage 電壓	Wattage 功率	Size 尺寸	Lamp Life 光度壽命	Colour Temp 色溫	Lumen Output 輸出流明	Color Rendering 顯色度	Beam Angle 發光角度	Operating Temperature 工作溫度
	(V)	(W)	(mm)	(Hrs)	(K)	(lm/W)	(CRI)	(°)	(°C)
EGB-0609	85-265	9	160*90	5000	3000	80	80	90	-20~45

Light efficiency (lm/W), Power (W), Color Rendering Index (CRI), Can be customized according to customer needs.

Our Standard Power factor (PF) > 0.9 and Total harmonic index THD < 15%, According to customer requirements can produce a lower THD < 10%.

This type of certification is issued by a government-approved laboratory for Safety certification, Fire testing, Restriction of Hazardous Substances (RoHS), Photobiological safety of lamps and lamp systems. (an Exemption Group) and other test certifications to ensure product quality

光效 (lm/W)、功率 (W)、顯色指數 (CRI)，可根據客戶需求定制。

此型號標準之功率因素 (PF) > 0.9，總諧波指數 THD < 15%，可按客戶需要生產低總諧波指數 < 10%。

此型號認證由可實驗室發出之安全認證消防測試，環保物料 (RoHS)，光生物安全為 Exemption Group 及其它測試，保證客戶使用更安心滿意。

LED Outdoor Embedded Buried Lamp

Series Type: ECBE070

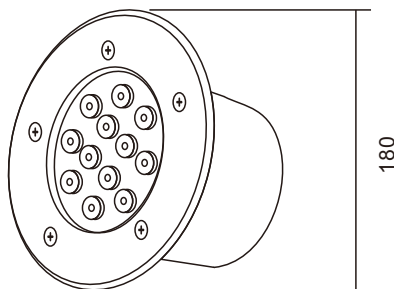

(Unit : mm)

Features 產品特點

- ★ The lamp body is made of integrally molded aluminum, with strong rigidity, fast heat dissipation, corrosion resistance and oxidation resistance.
- ★ The cover is made of 304 stainless steel, with wear resistance, corrosion resistance and strong rigidity.
- ★ The lampshade adopts transparent toughened glass, which has no yellowing, light transmission, abrasion resistance, rigidity and anti-aging.
- ★ High brightness LED lamp beads are adopted, with high luminous efficiency, less heating, long service life and low energy consumption.
- ★ The LED lamp board is made with waterproof glue filling process + glass lampshade and waterproof silicone sealing secondary waterproof process to ensure the safe use of the lamp outdoors.

- ★ 燈體採用一體成型出模的鋁材，剛性強、散熱快、耐腐蝕、抗氧化。
- ★ 面蓋採用304不銹鋼材質，耐磨損、抗腐蝕、剛性強。
- ★ 燈罩採用透明鋼化玻璃，不發黃、透光強、耐磨損、剛性強、抗老化。
- ★ 採用高亮度LED燈珠，光效高、發熱少、壽命長、能耗低。
- ★ LED燈板做了防水灌膠工藝+玻璃燈罩和防水矽膠密封二次防水工藝，保障燈在戶外的安全使用,IP65防水功能。

Specification 產品規格

Model 型號	Voltage 電壓	Wattage 功率	Size 尺寸	Lamp Life 光度壽命	Colour Temp 色溫	Lumen Output 輸出流明	Color Rendering 顯色度	Beam Angle 發光角度	Operating Temperature 工作溫度
	(V)	(W)	(mm)	(Hrs)	(K)	(Lm/W)	(CRI)	(°)	(°C)
EGB-0712	85-265	12	180*90	5000	3000	80	80	90	-20~45

Light efficiency (lm/W), Power (W), Color Rendering Index (CRI), Can be customized according to customer needs.

Our Standard Power factor (PF) > 0.9 and Total harmonic index THD < 15%, According to customer requirements can produce a lower THD < 10%.

This type of certification is issued by a government-approved laboratory for Safety certification, Fire testing, Restriction of Hazardous Substances (RoHS), Photobiological safety of lamps and lamp systems. (an Exemption Group) and other test certifications to ensure product quality

光效 (lm/W)、功率 (W)、顯色指數 (CRI)，可根據客戶需求定制。

此型號標準之功率因素 (PF) > 0.9，總諧波指數 THD < 15%，可按客戶需要生產低總諧波指數 < 10%。

此型號認證由可實驗室發出之安全認證消防測試，環保物料 (RoHS)，光生物安全為 Exemption Group 及其它測試，保證客戶使用更安心滿意。

LED Outdoor Embedded Buried Lamp

Series Type: ECBE080

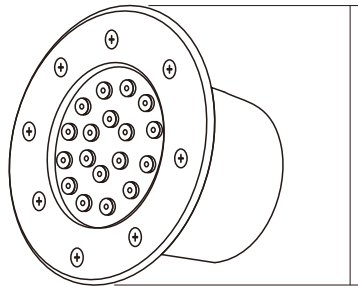

(Unit : mm)

Features 產品特點

- ★ The lamp body is made of integrally molded aluminum, with strong rigidity, fast heat dissipation, corrosion resistance and oxidation resistance.
- ★ The cover is made of 304 stainless steel, with wear resistance, corrosion resistance and strong rigidity.
- ★ The lampshade adopts transparent toughened glass, which has no yellowing, light transmission, abrasion resistance, rigidity and anti-aging.
- ★ High brightness LED lamp beads are adopted, with high luminous efficiency, less heating, long service life and low energy consumption.
- ★ The LED lamp board is made with waterproof glue filling process + glass lampshade and waterproof silicone sealing secondary waterproof process to ensure the safe use of the lamp outdoors.
- ★ 燈體採用一體成型出模的鋁材，剛性強、散熱快、耐腐蝕、抗氧化。
- ★ 面蓋採用304不銹鋼材質，耐磨損、抗腐蝕、剛性強。
- ★ 燈罩採用透明鋼化玻璃，不發黃、透光強、耐磨損、剛性強、抗老化。
- ★ 採用高亮度LED燈珠，光效高、發熱少、壽命長、能耗低。
- ★ LED燈板做了防水灌膠工藝+玻璃燈罩和防水矽膠密封二次防水工藝，保障燈在戶外的安全使用,IP65防水功能。

Specification 產品規格

Model 型號	Voltage 電壓	Wattage 功率	Size 尺寸	Lamp Life 光度壽命	Colour Temp 色溫	Lumen Output 輸出流明	Color Rendering 顯色度	Beam Angle 發光角度	Operating Temperature 工作溫度
	(V)	(W)	(mm)	(Hrs)	(K)	(Lm/W)	(CRI)	(°)	(°C)
EGB-0818	85-265	18	200*90	5000	3000	80	80	90	-20~45

Light efficiency (lm/W), Power (W), Color Rendering Index (CRI), Can be customized according to customer needs.

Our Standard Power factor (PF) > 0.9 and Total harmonic index THD < 15%, According to customer requirements can produce a lower THD < 10%.

This type of certification is issued by a government-approved laboratory for Safety certification, Fire testing, Restriction of Hazardous Substances (RoHS), Photobiological safety of lamps and lamp systems. (an Exemption Group) and other test certifications to ensure product quality

光效 (lm/W)、功率 (W)、顯色指數 (CRI)，可根據客戶需求定制。

此型號標準之功率因素 (PF) > 0.9，總諧波指數 THD < 15%，可按客戶需要生產低總諧波指數 < 10%。

此型號認證由可實驗室發出之安全認證消防測試，環保物料 (RoHS)，光生物安全為 Exemption Group 及其它測試，保證客戶使用更安心滿意。

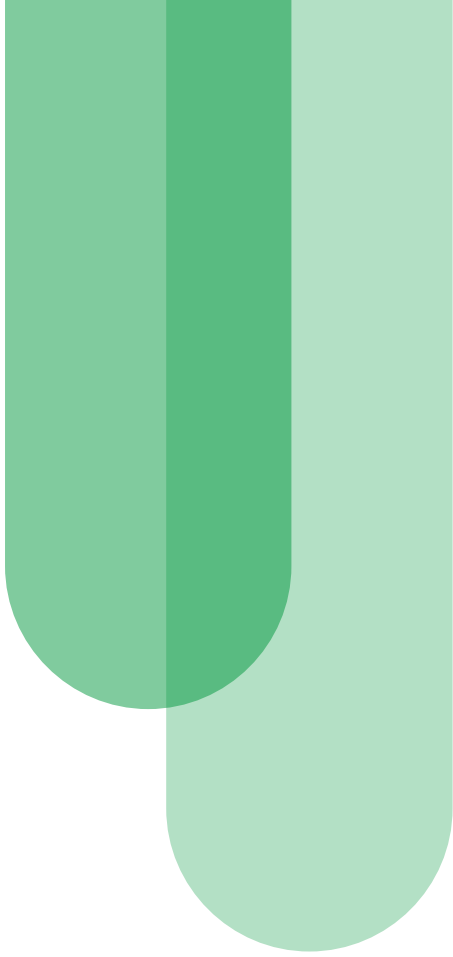

東 權 LED 照 明 公 司
EASTLIKE LED Co., Ltd

Office Address: Room B3, 18/F Bonsun Industrial Building,
364-366 Sha Tsui Road, Tsuen Wan, HongKong

Phone: 852-3974 5593

Fax: 852-3544 0462

Whatsapp: +852-6756 770

Email: info@eastlike.com