



CATALOG

LED lighting





公司簡介 Company Profile

LED Lighting

EAST

LED Lighting®
EAST



製造和營銷綠色低碳節能照明產品

Manufacturing And Marketing Green Low Carbon
And Energy Saving Lighting Products

EASTLIKE LED COMPANY 東 欏 照 明 公 司

EASTLIKE LED Co., Ltd • emerges as a lighting designer manufacturer and supplier established in Hong Kong and Mainland China .

The company devotes herself in the development, manufacturing and marketing of green, low-carbon and energy-saving lighting products. we are proud to provide a wide range of LED products

東欏LED照明公司 • 您的照明設計師。

我們作為製造商和供應服務於香港和中國大陸。公司致力於開發，製造和行銷綠色，低碳和節能照明產品。

我們竭誠為您服務，為您提供種類繁多的LED產品。

目錄

Content

P01-P09 LED Tube
LED燈管系列

P10-P35 Kitchen and Cabinet Light[®]
櫥櫃燈系列

P93-P51 Panel and Downlight
面板燈筒燈系列

P52-P63 Industrial Lighting Series
工業照明系列

P64-P81 Batten Luminaries
支架燈盤系列

P82-P99 Sensor Application
感應應用系列

P100-P111 Integrated Application
綜合應用系列

LED Tube



P.02
Commercial LED
T8 Tube



P.03
Wide Angle LED
T8 Tube



P.04
LED T5 Tube



P.05
Glass LED T8 Tube



P.06
DC LED T8 Tube
with External Driver



P.07
Dimmable LED T8 DC Tube
& 0-10V LED Driver



P.08
Dimmable LED T8 DC Tube
& DALI LED Driver



P.09
LED PLC Tube



Kitchen and Cabinet Light



P.11
CBL - P1010



P.12
CBL - P1013



P.13
CBL - P0707

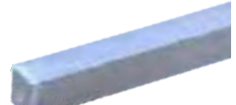

P.14
CBL - A1013



P.15
CBL - A3030



P.16
CBL - A1418



P.17
CBL - A2008



P.18
CBL - C2310L



P.19
CBL - C2408L



P.20
CBL - C1712L

Product Index



P.21
5050 Light Belt - Monochrome



P.22
Glue Water proof



P.23
RGB Waterproofing



P.24
Double Color

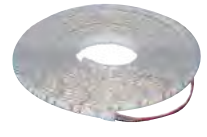

P.25
IP65 Hollow Light Belt

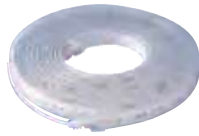

P.26
IP67 Hollow Light Belt

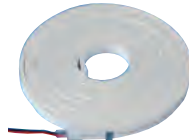

P.27
T5 Series Neon Light



P.28
T10 Series Neon Light



P.31
T15 Series Neon Light

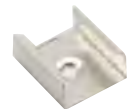

P.34
Installation Accessories

LED Lighting
EAST



Panel and Downlight



P.37
PL-PN-T



P.38
PL-PN-F



P.39
PL-PN-C



P.40
PL-PN-Z



P.41
PL-PN-JS



P.42
PL-PN-A



P.43
ILR-A



P.44
ILR-T-H



P.45
DL-T



P.46
DL-R



P.47
DL-UC



P.48
DL-S



P.49
TL-Q



P.50
TL-F2



P.51
TL-K

Industrial Lighting Series



P.53
FL-A-C



P.54
FL-A-H



P.55
FL-A100-H



P.56
FL-A-FQ



P.57
HB-A100-H148F-UFO



P.58
HB-A150-H148F-UFO

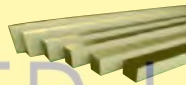

P.59
IPIL-58



P.60
SL-A-H



P.61
SL-A-H



P.62
SL-A-H



P.63
SSL-A

Batten Luminaries



P.65
DBA-S-EN



P.66
DBA-D-EN



P.67
DBA-S-EN-T5



P.68
DBA-D-EN-T5

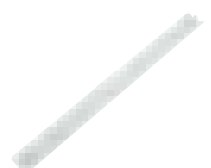

P.69
DBA-S-CY

Product Index



P.70
DBA-D-Y



P.71
DBA-S-N



P.72
IPB-EPL-G-S



P.73
IPB-EPL-G-D



P.74
IPBA-1240-M

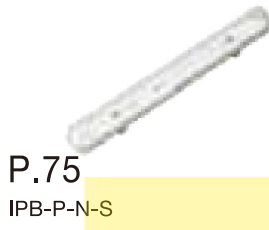

P.75
IPB-P-N-S



P.76
IPB-P-N-D

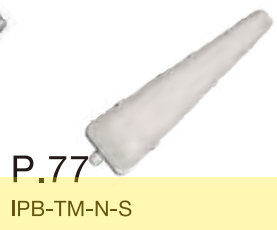

P.77
IPB-TM-N-S

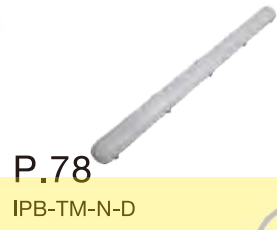

P.78
IPB-TM-N-D



P.79
GLA-D



P.80
GLP-F



P.81
GLP-D-N



Sensor Application



P.83
MC030SL



P.84
MC090SE



P.85
TR-8031



P.86
MC049V/MC083V RC



P.87
MC093S



P.88
M



P.89
IR



P.90
V



P.9
PS



P.9
M-AI



P.93
ML



P.94
BL-M-P



P.95
ILR-M



P.96
GY



P.97
BL-MT-P



P.98
BH-M-P



P.99
AS-M

LED Lighting

EAST



Integrated Application



P.101
BL-A-H



P.102
BL-A-E27



P.103
BL-A-E40



P.104
IMR-A-N



P.105
IMR-B-H



P.106
PAR20-B



P.107
PAR30-B



P.108
GB-H108E-NF



P.109
GB-H108A-NF



P.110
IPUW-2324



P.111
WL-P15



LED Lighting
LED-TUBE

燈管系列



東樞LED照明公司
EASTLIKE LED Co., Ltd

Office Address: Room B3, 18/F Bonsun Industrial Building, 364-366 Sha Tsui Road, Tsuen Wan, HongKong
Phone: 852-39745593 Fax: 852-35440462 info@eastlike.com www.eastlike.com

Commercial LED T8 Tube

Series Type: L

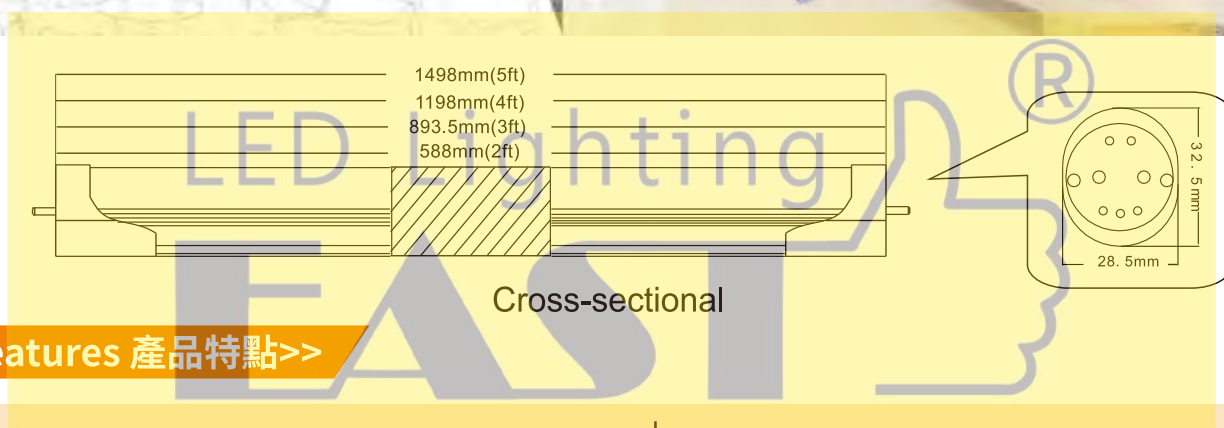

Features 產品特點>>

- ★ Uniform light emission
- ★ SPM Design – power circuit protection to cut off individual LEDs when mal-functioned
- ★ Optional: rotary end knob for angle adjustment

- ★ 發光均勻
- ★ SPM設計-電源電路保護，當個別led故障時切斷單個LED電路
- ★ 可選配：角度調節旋鈕

Specification 產品規格>>

Model 型號	Voltage 電壓 (V)	Wattage 功率 (W)	Length 長度 (mm)	Lamp Life 光度壽命 (Hrs)	Colour Temp 色溫 (K)	Lumen Output 輸出流明 (Lm/W)	Color Rendering 顯色度 (CRI)	Lamp Base 燈腳	PCS/CTN 每箱數量 (pcs)
EL-I0609-L128A	100~240	9	600	30,000	3000/4000/6500	100	>80	T8,G13	25
EL-I0912-L128A	100~240	12	900	30,000	3000/4000/6500	100	>80	T8,G13	25
EL-I1218-L128A	100~240	18	1200	30,000	3000/4000/6500	100	>80	T8,G13	25
EL-I1522-L128A	100~240	22	1500	30,000	3000/4000/6500	100	>80	T8,G13	25

Light efficiency (lm/W), Power (W), Color Rendering Index (CRI), Can be customized according to customer needs
 Our Standard Power factor (PF) > 0.9 and Total harmonic index THD < 15%, According to customer requirements can produce a lower THD < 10%
 This type of certification is issued by a government-approved laboratory for Safety certification, Fire testing, Restriction of Hazardous Substances (RoHS), Photobiological safety of lamps and lamp systems. (an Exemption Group) and other test certifications to ensure product quality

光效 (lm/W)、功率 (W)、顯色指數 (CRI)，可根據客戶需求定制
 此型號標準之功率因素 (PF) > 0.9，總諧波指數 THD < 15%，可按客戶需要生產低總諧波指數 < 10%
 此型號認證由可實驗室發出之安全認證消防測試，環保物料 (RoHS)，光生物安全為 Exemption Group 及其它測試，保證客戶使用更安心滿意



東樞 LED 照明公司
EASTLIKE LED Co., Ltd

Office Address: Room B3, 18/F Bonsun Industrial Building, 364-366 Sha Tsui Road, Tsuen Wan, HongKong
 Phone: 852-39745593 Fax: 852-35440462 info@eastlike.com www.eastlike.com

Wide Angle LED T8 Tube

Series Type: S

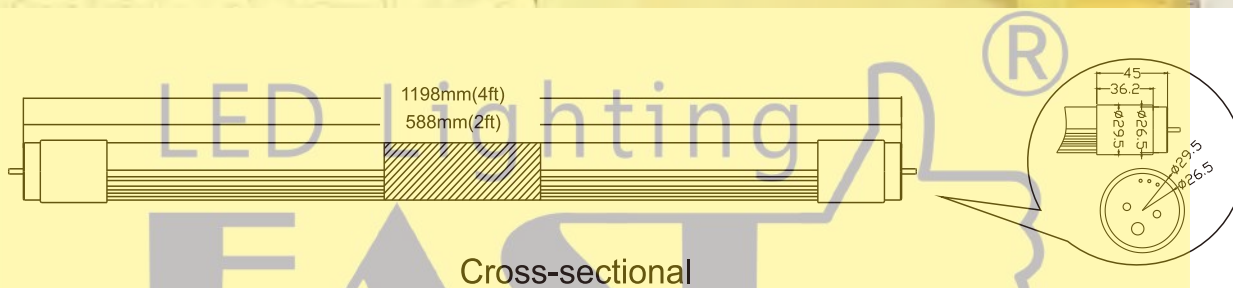

Features 產品特點>>

- ★ Uniform light emission
- ★ Retrofit to existing T8 lights on EM
- ★ SPM Design – power circuit protection to cut off individual LEDs when mal-functioned
- ★ Latest LED lighting standard IEC62560, EN62776, EN62493 certified
- ★ Wide angle (300 degrees) for best lighting effect
- ★ 均勻發光
- ★ 對現有的T8燈進行改造
- ★ SPM設計-電源電路保護, 當個別led故障時切斷單個LED電路
- ★ 最新LED照明標準IEC62560、EN62776、EN62493認證
- ★ 廣角(300度)提供最佳照明效果

Specification 產品規格>>

Model 型號	Voltage 電壓 (V)	Wattage 功率 (W)	Length 長度 (mm)	Lamp Life 光度壽命 (Hrs)	Colour Temp 色溫 (K)	Lumen Output 輸出流明 (Lm/W)	Color Rendering 顯色度 (CRI)	Lamp Base 燈腳	PCS/CTN 每箱數量 (pcs)
EL-I0609-S108A	100~240	9	600	30,000	3000/4000/6500	100	>80	T8,G13	25
EL-I1218-S108A	100~240	18	1200	30,000	3000/4000/6500	100	>80	T8,G13	25

Light efficiency (lm/W), Power (W), Color Rendering Index (CRI), Can be customized according to customer needs
 Our Standard Power factor (PF) > 0.9 and Total harmonic index THD < 15%, According to customer requirements can produce a lower THD < 10%
 This type of certification is issued by a government-approved laboratory for Safety certification, Fire testing, Restriction of Hazardous Substances (RoHS), Photobiological safety of lamps and lamp systems. (an Exemption Group) and other test certifications to ensure product quality

光效 (lm/W)、功率 (W)、顯色指數 (CRI), 可根據客戶需求定制
 此型號標準之功率因素 (PF) > 0.9, 總諧波指數 THD < 15%, 可按客戶需要生產低總諧波指數 < 10%
 此型號認證由可實驗室發出之安全認證消防測試, 環保物料 (RoHS), 光生物安全為 Exemption Group 及其它測試, 保證客戶使用更安心滿意



東欄 LED 照明公司
EASTLIKE LED Co., Ltd

Office Address: Room B3, 18/F Bonsun Industrial Building, 364-366 Sha Tsui Road, Tsuen Wan, HongKong
 Phone: 852-39745593 Fax: 852-35440462 info@eastlike.com www.eastlike.com

LED T5 Tube

Series Type:I5-N

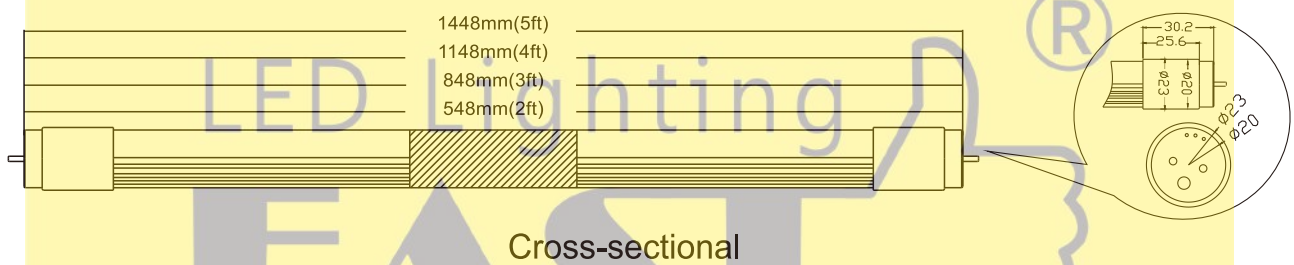

Features 產品特點>>

- ★ Uniform light emission
- ★ Retrofit to existing T5 lights
- ★ SPM Design – power circuit protection to cut off
- ★ T6 tube body to achieve the best lighting effect
- ★ Emergency option available: compatible in use with most emergency battery brands & comply with part A11 of FSD regulation PPA104

- ★ 均勻發光
- ★ 對現有T5燈進行改造
- ★ SPM設計-切斷電源電路保護
- ★ T6管體達到最佳照明效果
- ★ 可提供應急選項：與大多數應急電池品牌相容，並符合FSD法規PPA104第A11部分

Specification 產品規格>>

Model 型號	Voltage 電壓 (V)	Wattage 功率 (W)	Length 長度 (mm)	Lamp Life 光度壽命 (Hrs)	Colour Temp 色溫 (K)	Lumen Output 輸出流明 (Lm/W)	Color Rendering 顯色度 (CRI)	Lamp Base 燈腳	PCS/CTN 每箱數量 (pcs)
EL-I50608-N108A	100~240	8	600	30,000	3000/4000/6000	100	>80	T5,G5	50
EL-I50911-N108A	100~240	11	900	30,000	3000/4000/6000	100	>80	T5,G5	50
EL-I51216-N108A	100~240	16	1200	30,000	3000/4000/6000	100	>80	T5,G5	50
EL-I51520-N108A	100~240	20	1500	30,000	3000/4000/6000	100	>80	T5,G5	50

Light efficiency (lm/W), Power (W), Color Rendering Index (CRI), Can be customized according to customer needs
 Our Standard Power factor (PF) > 0.9 and Total harmonic index THD < 15%, According to customer requirements can produce a lower THD < 10%
 This type of certification is issued by a government-approved laboratory for Safety certification, Fire testing, Restriction of Hazardous Substances (RoHS), Photobiological safety of lamps and lamp systems. (an Exemption Group) and other test certifications to ensure product quality

光效 (lm/W)、功率 (W)、顯色指數 (CRI), 可根據客戶需求定制
 此型號標準之功率因素 (PF) > 0.9, 總諧波指數 THD < 15%, 可按客戶需要生產低總諧波指數 < 10%
 此型號認證由可實驗室發出之安全認證消防測試, 環保物料 (RoHS), 光生物安全為 Exemption Group 及其它測試, 保證客戶使用更安心滿意



東攏 LED 照明公司
EASTLIKE LED Co., Ltd

Office Address: Room B3, 18/F Bonsun Industrial Building, 364-366 Sha Tsui Road, Tsuen Wan, HongKong
 Phone: 852-39745593 Fax: 852-35440462 info@eastlike.com www.eastlike.com

Glass LED T8 Tube

Series Type: G

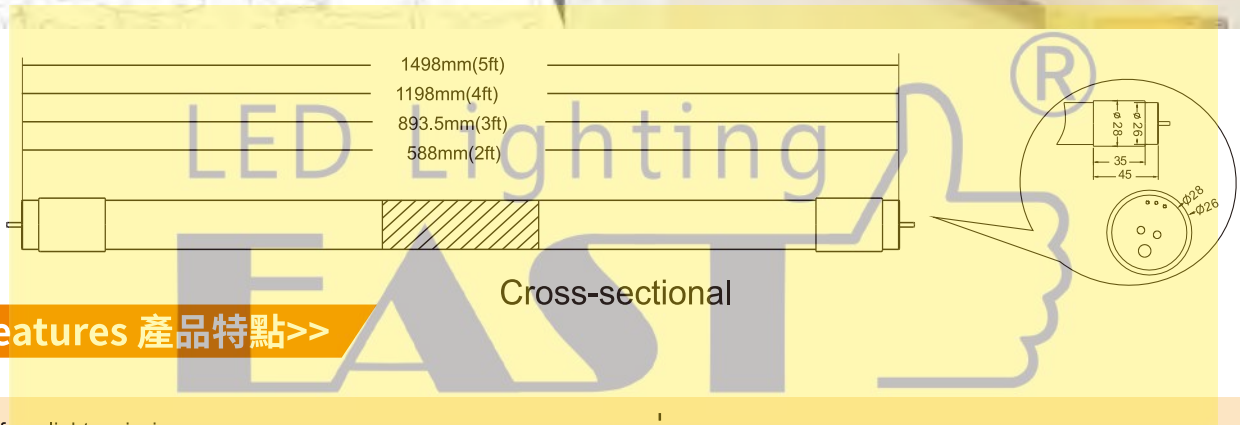

Features 產品特點>>

- ★ Uniform light emission
- ★ High luminous output & low power consumption
- ★ Retrofit to existing T8 lights on EM
- ★ SPM design – Power circuit protection to cut off individual LEDs when mal-functioned
- ★ Beam Angl : 300 degree

- ★ 發光均勻
- ★ 高光輸出和低功耗
- ★ 對現有T8燈進行改進
- ★ SPM設計即電源電路保護，在故障時可立即切斷單個LED電路
- ★ 光束角度：300度

Specification 產品規格>>

Model 型號	Voltage 電壓 (V)	Wattage 功率 (W)	Length 長度 (mm)	Lamp Life 光度壽命 (Hrs)	Colour Temp 色溫 (K)	Lumen Output 輸出流明 (Lm/W)	Color Rendering 顯色度 (CRI)	Lamp Base 燈腳	PCS/CTN 每箱數量 (pcs)
EL-I0609-G108A	100~240	9	600	30,000	3000/4000/6500	100	>80	T8,G13	25
EL-I0912-G108A	100~240	12	900	30,000	3000/4000/6500	100	>80	T8,G13	25
EL-I1218-G108A	100~240	18	1200	30,000	3000/4000/6500	100	>80	T8,G13	25
EL-I1522-G108A	100~240	22	1500	30,000	3000/4000/6500	100	>80	T8,G13	25

Light efficiency (lm/W), Power (W), Color Rendering Index (CRI), Can be customized according to customer needs
 Our Standard Power factor (PF) > 0.9 and Total harmonic index THD < 15%, According to customer requirements can produce a lower THD < 10%
 This type of certification is issued by a government-approved laboratory for Safety certification, Fire testing, Restriction of Hazardous Substances (RoHS), Photobiological safety of lamps and lamp systems. (an Exemption Group) and other test certifications to ensure product quality

光效 (lm/W)、功率 (W)、顯色指數 (CRI)，可根據客戶需求定制
 此型號標準之功率因素 (PF) > 0.9，總諧波指數 THD < 15%，可按客戶需要生產低總諧波指數 < 10%
 此型號認證由實驗室發出之安全認證消防測試，環保物料 (RoHS)，光生物安全為 Exemption Group 及其它測試，保證客戶使用更安心滿意



東權 LED 照明公司
EASTLIKE LED Co., Ltd

Office Address: Room B3, 18/F Bonsun Industrial Building, 364-366 Sha Tsui Road, Tsuen Wan, HongKong
 Phone: 852-39745593 Fax: 852-35440462 info@eastlike.com www.eastlike.com

DC LED T8 Tube with External Driver

Series Type:R-N

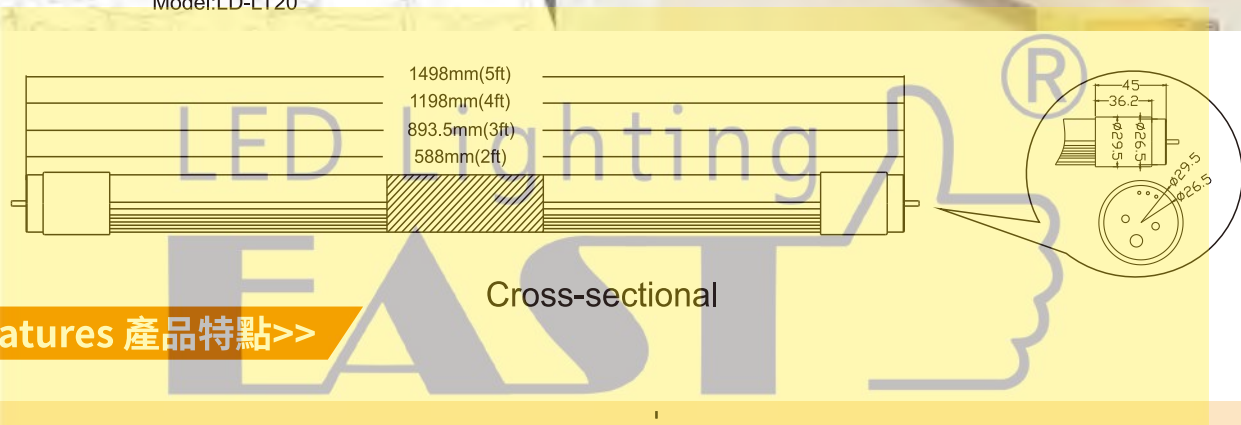
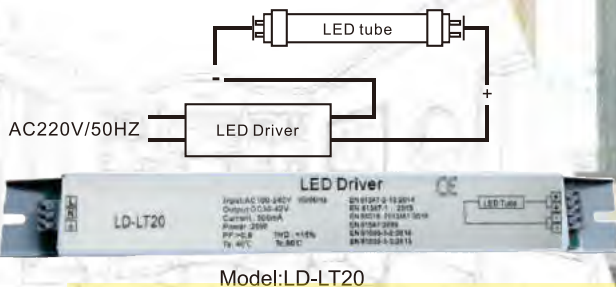

Features 產品特點>>

- ★ Uniform light emission
- ★ Retrofit to existing T8 lights on EM
- ★ SPM Design – power circuit protection to cut off individual LEDs when mal-functioned

- ★ 發光均勻
- ★ 對現有T8燈進行改進
- ★ SPM設計即電源電路保護,在故障時可立即切斷單個LED電路

Specification 產品規格>>

Model 型號	Voltage 電壓 (V)	Wattage 功率 (W)	Length 長度 (mm)	Lamp Life 光度壽命 (Hrs)	Colour Temp 色溫 (K)	Lumen Output 輸出流明 (Lm/W)	Color Rendering 顯色度 (CRI)	Lamp Base 燈腳	PCS/CTN 每箱數量 (pcs)
EL-R0609-N108A	30-42	9	600	30,000	3000/4000/6000	100	>80	T8,G13	25
EL-R0912-N108A	30-42	12	900	30,000	3000/4000/6000	100	>80	T8,G13	25
EL-R1218-N108A	30-42	18	1200	30,000	3000/4000/6000	100	>80	T8,G13	25
EL-R1522-N108A	30-42	22	1500	30,000	3000/4000/6000	100	>80	T8,G13	25

Light efficiency (lm/W), Power (W), Color Rendering Index (CRI), Can be customized according to customer needs
 Our Standard Power factor (PF) > 0.9 and Total harmonic index THD < 15%, According to customer requirements can produce a lower THD < 10%
 This type of certification is issued by a government-approved laboratory for Safety certification, Fire testing, Restriction of Hazardous Substances (RoHS), Photobiological safety of lamps and lamp systems. (an Exemption Group) and other test certifications to ensure product quality

光效 (lm/W)、功率 (W)、顯色指數 (CRI), 可根據客戶需求定制
 此型號標準之功率因素 (PF) > 0.9, 總諧波指數 THD < 15%, 可按客戶需要生產低總諧波指數 < 10%
 此型號認證由可實驗室發出之安全認證消防測試, 環保物料 (RoHS), 光生物安全為 Exemption Group 及其它測試, 保證客戶使用更安心滿意



東攏 LED 照明公司
EASTLIKE LED Co., Ltd

Office Address: Room B3, 18/F Bonsun Industrial Building, 364-366 Sha Tsui Road, Tsuen Wan, HongKong
 Phone: 852-39745593 Fax: 852-35440462 info@eastlike.com www.eastlike.com

Dimmable LED T8 DC Tube & 0-10V LED Driver

Series Type:R-N

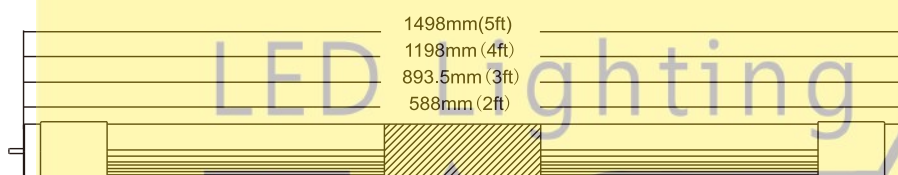
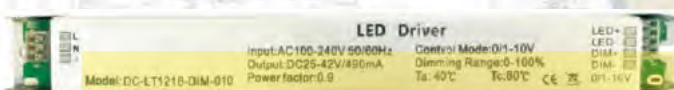
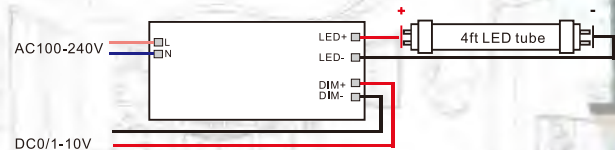

Cross-sectional

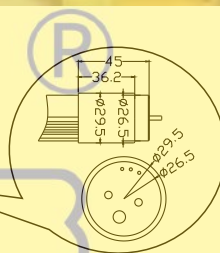

Features 產品特點>>

- ★ Dimming interface: 0-10V Dim
- ★ Apply to leading edge and trailing edge 0-10V dimmers
- ★ Dimming range from 0-100%
- ★ Compliant with safety extra low voltage standard

- ★ 調光介面: 0-10V調光
- ★ 適用於前緣和後緣0-10V調光器
- ★ 調光範圍0-100%
- ★ 符合安全特低電壓標準相容

Specification 產品規格>>

Model 型號	Voltage 電壓 (V)	Wattage 功率 (W)	Length 長度 (mm)	Lamp Life 光度壽命 (Hrs)	Colour Temp 色溫 (K)	Lumen Output 輸出流明 (Lm/W)	Color Rendering 顯色度 (CRI)	Lamp Base 燈腳	PCS/CTN 每箱數量 (pcs)
EL-R0609-N108A	30-42	9	600	30,000	4000	100	>80	T8,G13	25
EL-R0912-N108A	30-42	12	900	30,000	4000	100	>80	T8,G13	25
EL-R1218-N108A	30-42	18	1200	30,000	4000	100	>80	T8,G13	25
EL-R1522-N108A	30-42	22	1500	30,000	4000	100	>80	T8,G13	25

Light efficiency (lm/W), Power (W), Color Rendering Index (CRI), Can be customized according to customer needs

Our Standard Power factor (PF) > 0.9 and Total harmonic index THD < 15%, According to customer requirements can produce a lower THD < 10%

This type of certification is issued by a government-approved laboratory for Safety certification, Fire testing, Restriction of Hazardous Substances (RoHS), Photobiological safety of lamps and lamp systems. (an Exemption Group) and other test certifications to ensure product quality

光效 (lm/W)、功率 (W)、顯色指數 (CRI), 可根據客戶需求定制

此型號標準之功率因素 (PF) > 0.9, 總諧波指數 THD < 15%, 可按客戶需要生產低總諧波指數 < 10%

此型號認證由可實驗室發出之安全認證消防測試, 環保物料 (RoHS), 光生物安全為 Exemption Group 及其它測試, 保證客戶使用更安心滿意



東權 LED 照明公司
EASTLIKE LED Co., Ltd

Office Address: Room B3, 18/F Bonsun Industrial Building, 364-366 Sha Tsui Road, Tsuen Wan, HongKong
Phone: 852-39745593 Fax: 852-35440462 info@eastlike.com www.eastlike.com

LED PLC Tube

Series Type: IPL-C05

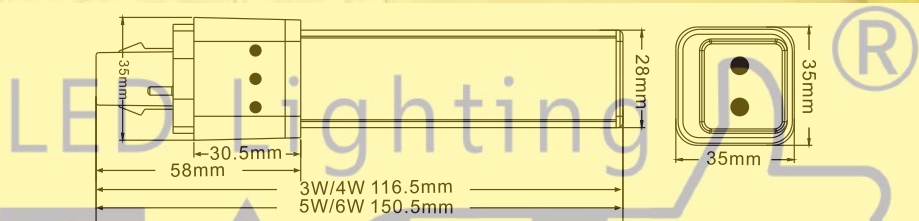

Features 產品特點>>

Cross-sectional

- ★ Energy saving: It save 80% energy than traditional incandescent bulb
- ★ Eco-Green: No radiation, no mercury, no lead, no harmful elements, all products can be recycled
- ★ Long life span: 50,000 hours, 10 times over than traditional light
- ★ High light Efficiency: The product can reach,120lm/W
- ★ It is safe and easy to be used and installed
- ★ This product is good for workshop, office, bank, hospital, shopping centre , subway, school, and other indoor places which require light of high luminosity and energy-saving

- ★ 節能:比傳統白熾燈泡節能80%
- ★ 生態綠色:無輻射、無汞、無鉛、無有害元素,所有產品均可回收利用
- ★ 壽命長:使用壽命50000小時,是傳統光源的10倍
- ★ 高光效:產品可達120lm/W
- ★ 它很安全,易於使用和安裝
- ★ 本產品適用於車間、辦公室、銀行、醫院、商場、捷運、學校等要求高亮度、節能的室內場所

Specification 產品規格>>

Model 型號	Voltage 電壓	Wattage 功率	Standard size 標準尺寸	Lamp Life 光度壽命	Colour Temp 色溫	Lumen Output 輸出流明	Color Rendering 顯色度	Operating Temperature 工作溫度	Lamp Base 燈腳	PCS/CTN 每箱數量
	(V)	(W)	(mm)	(Hrs)	(K)	(Lm/W)	(CRI)	(°C)		(pcs)
IPL-C03-H108A	85~265	3	35*35*116.5	30,000	3000/4000/6500	100	>80	-20~40	G24	25
IPL-C04-H108A	85~265	4	35*35*116.5	30,000	3000/4000/6500	100	>80	-20~40	G24	25
IPL-C05-H108A	85~265	5	35*35*150.5	30,000	3000/4000/6500	100	>80	-20~40	G24	25
IPL-C06-H108A	85~265	6	35*35*150.5	30,000	3000/4000/6500	100	>80	-20~40	G24	25

Light efficiency (lm/W), Power (W), Color Rendering Index (CRI), Can be customized according to customer needs
 Our Standard Power factor (PF) > 0.9 and Total harmonic index THD < 15%, According to customer requirements can produce a lower THD < 10%
 This type of certification is issued by a government-approved laboratory for Safety certification, Fire testing, Restriction of Hazardous Substances (RoHS), Photobiological safety of lamps and lamp systems. (an Exemption Group) and other test certifications to ensure product quality

光效 (lm/W)、功率 (W)、顯色指數 (CRI), 可根據客戶需求定制
 此型號標準之功率因素 (PF) > 0.9, 總諧波指數 THD < 15%, 可按客戶需要生產低總諧波指數 < 10%
 此型號認證由可實驗室發出之安全認證消防測試, 環保物料 (RoHS), 光生物安全為 Exemption Group 及其它測試, 保證客戶使用更安心滿意



東權 LED 照明公司
 EASTLIKE LED Co., Ltd

Office Address: Room B3, 18/F Bonsun Industrial Building, 364-366 Sha Tsui Road, Tsuen Wan, HongKong
 Phone: 852-39745593 Fax: 852-35440462 info@eastlike.com www.eastlike.com



LED Lighting Kitchen and Cabinet Light

櫥櫃燈系列



東灑LED照明公司
EASTLIKE LED Co., Ltd

Office Address: Room B3, 18/F Bonsun Industrial Building, 364-366 Sha Tsui Road, Tsuen Wan, HongKong
Phone: 852-39745593 Fax: 852-35440462 info@eastlike.com www.eastlike.com

Thermal Conductive LED Light Strip

Series Type: P1010



LED Lighting

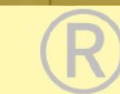
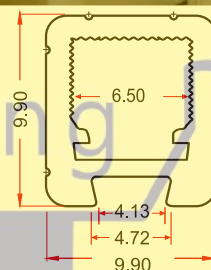

Unit: mm

Features 產品特點>>

- ★ Size: 9.9mm (W) x 9.9mm (H)
- ★ Uniform light emission without LED spot, 270 degree (3-sectional) lighting output
- ★ SPM Design – power circuit protection to cut off individual LEDs when mal-functioned
- ★ Minimum cutting length < 3mm,
- ★ Thermal conductive plastic to maximize heat dissipation
- ★ Installation in serial for seamless lighting output
- ★ Application: Kitchen cabinet, Bathroom cabinet, Closet, Show cabinet, Retail chop , etc

- ★ 尺寸: 9.9毫米(寬)x9.9毫米(高)
- ★ 發光均勻,無LED光點, 270度(3段)照明輸出
- ★ 使用SPM設計-電源電路保護, 在故障時切斷單個LED
- ★ 最小切割長度<3mm
- ★ 採用最佳散熱的導熱塑膠
- ★ 串聯安裝以實現無縫照明輸出
- ★ 應用: 廚櫃、浴室櫃、衣櫃、展示櫃、零售店等

Specification 產品規格>>

Model 型號	DC Voltage 電壓 (V)	Wattage 功率 (W)	Length 長度 (mm)	Lamp Life 光度壽命 (Hrs)	Colour Temp 色溫 (K)	Lumen Output 輸出流明 (Lm/W)	Color Rendering 顯色度 (CRI)	Beam Angle 光速角度 (°)	Operating Temperature 工作溫度 (°C)
CBL-P1010-S1004-109A	12/24	4	1000	30,000	2700/3000/4000/6500	100	>90	270	-20~+45
CBL-P1010-S1008-109A	12/24	8	1000	30,000	2700/3000/4000/6500	100	>90	270	-20~+45
CBL-P1010-S1205-109A	12/24	5	1200	30,000	2700/3000/4000/6500	100	>90	270	-20~+45
CBL-P1010-S1210-109A	12/24	10	1200	30,000	2700/3000/4000/6500	100	>90	270	-20~+45

Light efficiency (lm/W), Power (W), Color Rendering Index (CRI), Length Can be customized according to customer needs
 Our Standard Power factor (PF) > 0.9 and Total harmonic index THD < 15%, According to customer requirements can produce a lower THD < 10%
 This type of certification is issued by a government-approved laboratory for Safety certification, Fire testing, Restriction of Hazardous Substances (RoHS), Photobiological safety of lamps and lamp systems. (an Exemption Group) and other test certifications to ensure product quality

光效 (lm/W)、功率 (W)、顯色指數 (CRI)、長度, 可根據客戶需求定制
 此型號標準之功率因素 (PF) > 0.9, 總諧波指數 THD < 15%, 可按客戶需要生產低總諧波指數 < 10%
 此型號認證由可實驗室發出之安全認證消防測試, 環保物料 (RoHS), 光生物安全為 Exemption Group 及其它測試, 保證客戶使用更安心滿意



東權 LED 照明公司
EASTLIKE LED Co., Ltd

Office Address: Room B3, 18/F Bonsun Industrial Building, 364-366 Sha Tsui Road, Tsuen Wan, HongKong
 Phone: 852-39745593 Fax: 852-35440462 info@eastlike.com www.eastlike.com

Thermal Conductive LED Light Strip

Series Type:P1013



LED Lighting

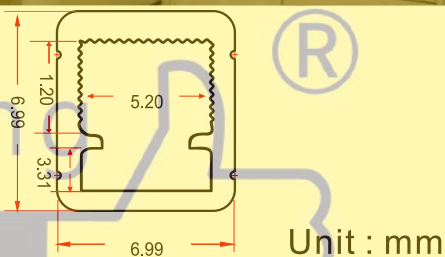

Features 產品特點>>

- ★ Size: 10.00mm (W) x 13.00mm (H)
- ★ Uniform light emission without LED spot, 270 degree (3-sectional) lighting output
- ★ SPM Design – power circuit protection to cut off individual LEDs when mal-functioned
- ★ Minimum cutting length < 3mm,
- ★ Thermal conductive plastic to maximize heat dissipation
- ★ Installation in serial for seamless lighting output
- ★ Application: Kitchen cabinet, Bathroom cabinet, Closet, Show cabinet, Retail chop , etc

Specification 產品規格>>

Model 型號	DC Voltage 電壓	Wattage 功率	Length 長度	Lamp Life 光度壽命	Colour Temp 色溫	Lumen Output 輸出流明	Color Rendering 顯色度	Beam Angle 光速角度	Operating Temperature 工作溫度
	(V)	(W)	(mm)	(Hrs)	(K)	(Lm/W)	(CRI)	(°)	(°C)
CBL-P1013-S1004-109A	12/24	4	1000	30,000	2700/3000/4000/6500	100	>90	270	-20~+45
CBL-P1013-S1008-109A	12/24	8	1000	30,000	2700/3000/4000/6500	100	>90	270	-20~+45
CBL-P1013-S1205-109A	12/24	5	1200	30,000	2700/3000/4000/6500	100	>90	270	-20~+45
CBL-P1013-S1210-109A	12/24	10	1200	30,000	2700/3000/4000/6500	100	>90	270	-20~+45

Light efficiency (lm/W), Power (W), Color Rendering Index (CRI), Length Can be customized according to customer needs
 Our Standard Power factor (PF) > 0.9 and Total harmonic index THD < 15%, According to customer requirements can produce a lower THD < 10%
 This type of certification is issued by a government-approved laboratory for Safety certification, Fire testing, Restriction of Hazardous Substances (RoHS), Photobiological safety of lamps and lamp systems. (an Exemption Group) and other test certifications to ensure product quality

光效 (lm/W)、功率 (W)、顯色指數 (CRI)、長度, 可根據客戶需求定制
 此型號標準之功率因素 (PF) > 0.9, 總諧波指數 THD < 15%, 可按客戶需要生產低總諧波指數 < 10%
 此型號認證由實驗室發出之安全認證消防測試, 環保物料 (RoHS), 光生物安全為 Exemption Group 及其它測試, 保證客戶使用更安心滿意



東欄 LED 照明公司
EASTLIKE LED Co., Ltd

Office Address: Room B3, 18/F Bonsun Industrial Building, 364-366 Sha Tsui Road, Tsuen Wan, HongKong
 Phone: 852-39745593 Fax: 852-35440462 info@eastlike.com www.eastlike.com

Thermal Conductive LED Light Strip

Series Type: P0707



LED Lighting

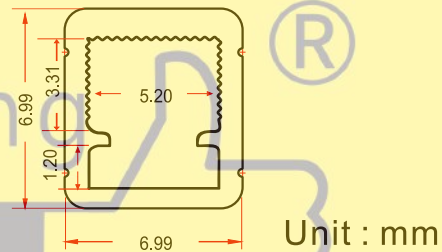

Features 產品特點>>

- ★ Size: 6.99mm (W) x 6.99mm (H)
 - ★ Uniform light emission without LED spot, 270 degree (3-sectional) lighting output
 - ★ SPM Design – power circuit protection to cut off individual LEDs when mal-functioned
 - ★ Minimum cutting length < 3mm,
 - ★ Thermal conductive plastic to maximize heat dissipation
 - ★ Installation in serial for seamless lighting output
 - ★ Application: Kitchen cabinet, Bathroom cabinet, Closet, Show cabinet, Retail chop , etc
- ★ 尺寸: 6.99毫米(寬)x6.99毫米(高)
 - ★ 發光均勻,無LED光點, 270度(3段)照明輸出
 - ★ 使用SPM設計-電源電路保護, 在故障時切斷單個LED
 - ★ 最小切割長度<3mm
 - ★ 採用最佳散熱的導熱塑膠
 - ★ 串聯安裝以實現無縫照明輸出
 - ★ 應用: 廚櫃、浴室櫃、衣櫃、展示櫃、零售店等

Specification 產品規格>>

Model 型號	DC Voltage 電壓	Wattage 功率	Length 長度	Lamp Life 光度壽命	Colour Temp 色溫	Lumen Output 輸出流明	Color Rendering 顯色度	Beam Angle 光速角度	Operating Temperature 工作溫度
	(V)	(W)	(mm)	(Hrs)	(K)	(Lm/W)	(CRI)	(°)	(°C)
CBL-P0707-S1004-109A	12/24	4	1000	30,000	2700/3000/4000/6500	100	>90	270	-20~+45
CBL-P0707-S1008-109A	12/24	8	1000	30,000	2700/3000/4000/6500	100	>90	270	-20~+45
CBL-P0707-S1205-109A	12/24	5	1200	30,000	2700/3000/4000/6500	100	>90	270	-20~+45
CBL-P0707-S1210-109A	12/24	10	1200	30,000	2700/3000/4000/6500	100	>90	270	-20~+45

Light efficiency (lm/W), Power (W), Color Rendering Index (CRI), Length Can be customized according to customer needs
 Our Standard Power factor (PF) > 0.9 and Total harmonic index THD < 15%, According to customer requirements can produce a lower THD < 10%
 This type of certification is issued by a government-approved laboratory for Safety certification, Fire testing, Restriction of Hazardous Substances (RoHS), Photobiological safety of lamps and lamp systems. (an Exemption Group) and other test certifications to ensure product quality

光效 (lm/W)、功率 (W)、顯色指數 (CRI)、長度, 可根據客戶需求定制
 此型號標準之功率因素 (PF) > 0.9, 總諧波指數 THD < 15%, 可按客戶需要生產低總諧波指數 < 10%
 此型號認證由可實驗室發出之安全認證消防測試, 環保物料 (RoHS), 光生物安全為 Exemption Group 及其它測試, 保證客戶使用更安心滿意



東權 LED 照明公司
EASTLIKE LED Co., Ltd

Office Address: Room B3, 18/F Bonsun Industrial Building, 364-366 Sha Tsui Road, Tsuen Wan, HongKong
 Phone: 852-39745593 Fax: 852-35440462 info@eastlike.com www.eastlike.com

Aluminum LED Strip

Series Type: A1013



LED Lighting

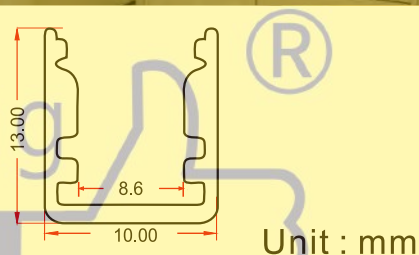

Features 產品特點>>

- ★ PC cover : milky
- ★ Size: 10 mm (W) x 13 mm (H)
- ★ SPM Design – power circuit protection to cut off individual LEDs when mal-functioned
- ★ Aluminum to maximize heat dissipation
- ★ Installation in serial for seamless lighting output
- ★ Uniform light emission without LED spot
- ★ Application: Kitchen cabinet, Bathroom cabinet, Closet, Show cabinet, Retail shop, etc

- ★ PC蓋: 乳白色
- ★ 尺寸: 10毫米(寬)X13毫米(高)
- ★ 使用SPM設計-電源電路保護, 在故障時切斷單個LED
- ★ 採用鋁框架使散熱最大化
- ★ 串聯安裝以實現無縫照明輸出
- ★ 發光均勻, 無LED光點
- ★ 應用: 廚櫃、浴室櫃、壁櫥、展示櫃、零售店等

Specification 產品規格>>

Model 型號	DC Voltage 電壓	Wattage 功率	Length 長度	Lamp Life 光度壽命	Colour Temp 色溫	Lumen Output 輸出流明	Color Rendering 顯色度	Beam Angle 光速角度	Operating Temperature 工作溫度
	(V)	(W)	(mm)	(Hrs)	(K)	(Lm/W)	(CRI)	(°)	(°C)
CBL-A1013-S1004-109A	12/24	4	1000	30,000	2700/3000/4000/6500	100	>90	120	-20~+45
CBL-A1013-S1008-109A	12/24	8	1000	30,000	2700/3000/4000/6500	100	>90	120	-20~+45
CBL-A1013-S1205-109A	12/24	5	1200	30,000	2700/3000/4000/6500	100	>90	120	-20~+45
CBL-A1013-S1210-109A	12/24	10	1200	30,000	2700/3000/4000/6500	100	>90	120	-20~+45

Light efficiency (lm/W), Power (W), Color Rendering Index (CRI), Length Can be customized according to customer needs
 Our Standard Power factor (PF) > 0.9 and Total harmonic index THD < 15%, According to customer requirements can produce a lower THD < 10%
 This type of certification is issued by a government-approved laboratory for Safety certification, Fire testing, Restriction of Hazardous Substances (RoHS), Photobiological safety of lamps and lamp systems. (an Exemption Group) and other test certifications to ensure product quality

光效 (lm/W)、功率 (W)、顯色指數 (CRI)、長度, 可根據客戶需求定制
 此型號標準之功率因素 (PF) > 0.9, 總諧波指數 THD < 15%, 可按客戶需要生產低總諧波指數 < 10%
 此型號認證由實驗室發出之安全認證消防測試, 環保物料 (RoHS), 光生物安全為 Exemption Group 及其它測試, 保證客戶使用更安心滿意



東櫥 LED 照明公司
EASTLIKE LED Co., Ltd

Office Address: Room B3, 18/F Bonsun Industrial Building, 364-366 Sha Tsui Road, Tsuen Wan, HongKong
 Phone: 852-39745593 Fax: 852-35440462 info@eastlike.com www.eastlike.com

Aluminum LED Strip

Series Type: A3030



LED Lighting



Features 產品特點>>

- ★ PC cover : milky
- ★ Size:30 mm (W) x 30mm (H)
- ★ SPM Design – power circuit protection to cut off individual LEDs when mal-functioned
- ★ Aluminum to maximize heat dissipation
- ★ Installation in serial for seamless lighting output
- ★ Uniform light emission without LED spot
- ★ Application: Kitchen cabinet, Bathroom cabinet ,Closet, Show cabinet, Retail shop,etc

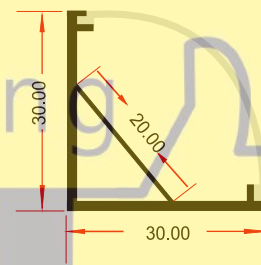

Unit : mm

- ★ PC蓋:乳白色
- ★ 尺寸: 30毫米(寬)X30毫米(高)
- ★ 使用SPM設計-電源電路保護,在故障時切斷單個LED
- ★ 採用鋁框架使散熱最大化
- ★ 串聯安裝以實現無縫照明輸出
- ★ 發光均勻,無LED光點
- ★ 應用:廚櫃、浴室櫃、壁櫥、展示櫃、零售店等

Specification 產品規格>>

Model 型號	DC Voltage 電壓	Wattage 功率	Length 長度	Lamp Life 光度壽命	Colour Temp 色溫	Lumen Output 輸出流明	Color Rendering 顯色度	Beam Angle 光速角度	Operating Temperature 工作溫度
	(V)	(W)	(mm)	(Hrs)	(K)	(Lm/W)	(CRI)	(°)	(°C)
CBL-A3030-S1008-109A	12/24	4	1000	30,000	2700/3000/4000/6500	100	>90	120	-20~+45
CBL-A3030-S1010-109A	12/24	8	1000	30,000	2700/3000/4000/6500	100	>90	120	-20~+45
CBL-A3030-S1210-109A	12/24	5	1200	30,000	2700/3000/4000/6500	100	>90	120	-20~+45
CBL-A3030-S1214-109A	12/24	10	1200	30,000	2700/3000/4000/6500	100	>90	120	-20~+45

Light efficiency (lm/W), Power (W), Color Rendering Index (CRI), Length Can be customized according to customer needs
 Our Standard Power factor (PF) > 0.9 and Total harmonic index THD < 15%, According to customer requirements can produce a lower THD < 10%
 This type of certification is issued by a government-approved laboratory for Safety certification, Fire testing, Restriction of Hazardous Substances (RoHS), Photobiological safety of lamps and lamp systems. (an Exemption Group) and other test certifications to ensure product quality

光效 (lm/W)、功率 (W)、顯色指數 (CRI)、長度, 可根據客戶需求定制
 此型號標準之功率因素 (PF) > 0.9, 總諧波指數 THD < 15%, 可按客戶需要生產低總諧波指數 < 10%
 此型號認證由可實驗室發出之安全認證消防測試, 環保物料 (RoHS), 光生物安全為 Exemption Group 及其它測試, 保證客戶使用更安心滿意



東權 LED 照明公司
EASTLIKE LED Co., Ltd

Office Address: Room B3, 18/F Bonsun Industrial Building, 364-366 Sha Tsui Road, Tsuen Wan, HongKong
 Phone: 852-39745593 Fax: 852-35440462 info@eastlike.com www.eastlike.com

Aluminum LED Strip

Series Type: A1418



LED Lighting

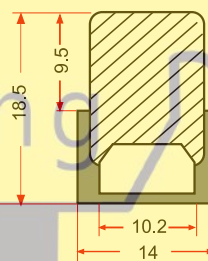

Unit : mm

Features 產品特點>>

- ★ PC cover : milky
- ★ Size:14 mm (W) x 18.5 mm (H)
- ★ SPM Design – power circuit protection to cut off individual LEDs when mal-functioned
- ★ Aluminum to maximize heat dissipation
- ★ Installation in serial for seamless lighting output
- ★ Uniform light emission without LED spot
- ★ Application: Kitchen cabinet, Bathroom cabinet ,Closet, Show cabinet, Retail shop,etc

- ★ PC蓋:乳白色
- ★ 尺寸:14毫米(寬)X18.5毫米(高)
- ★ 使用SPM設計-電源電路保護,在故障時切斷單個LED
- ★ 採用鋁框架使散熱最大化
- ★ 串聯安裝以實現無縫照明輸出
- ★ 發光均勻,無LED光點
- ★ 應用:廚櫃、浴室櫃、壁櫥、展示櫃、零售店等

Specification 產品規格>>

Model 型號	DC Voltage 電壓	Wattage 功率	Length 長度	Lamp Life 光度壽命	Colour Temp 色溫	Lumen Output 輸出流明	Color Rendering 顯色度	Beam Angle 光速角度	Operating Temperature 工作溫度
	(V)	(W)	(mm)	(Hrs)	(K)	(Lm/W)	(CRI)	(°)	(°C)
CBL-A1418-S1004-109A	12/24	4	1000	30,000	2700/3000/4000/6500	100	>90	180	-20~+45
CBL-A1418-S1008-109A	12/24	8	1000	30,000	2700/3000/4000/6500	100	>90	180	-20~+45
CBL-A1418-S1205-109A	12/24	5	1200	30,000	2700/3000/4000/6500	100	>90	180	-20~+45
CBL-A1418-S1210-109A	12/24	10	1200	30,000	2700/3000/4000/6500	100	>90	180	-20~+45

Light efficiency (lm/W), Power (W), Color Rendering Index (CRI), Length Can be customized according to customer needs
 Our Standard Power factor (PF) > 0.9 and Total harmonic index THD < 15%, According to customer requirements can produce a lower THD < 10%
 This type of certification is issued by a government-approved laboratory for Safety certification, Fire testing, Restriction of Hazardous Substances (RoHS), Photobiological safety of lamps and lamp systems. (an Exemption Group) and other test certifications to ensure product quality

光效 (lm/W)、功率 (W)、顯色指數 (CRI)、長度, 可根據客戶需求定制
 此型號標準之功率因素 (PF) > 0.9, 總諧波指數 THD < 15%, 可按客戶需要生產低總諧波指數 < 10%
 此型號認證由實驗室發出之安全認證消防測試, 環保物料 (RoHS), 光生物安全為 Exemption Group 及其它測試, 保證客戶使用更安心滿意



東櫥 LED 照明公司
EASTLIKE LED Co., Ltd

Office Address: Room B3, 18/F Bonsun Industrial Building, 364-366 Sha Tsui Road, Tsuen Wan, HongKong
 Phone: 852-39745593 Fax: 852-35440462 info@eastlike.com www.eastlike.com

Aluminum LED Strip

Series Type: A2008

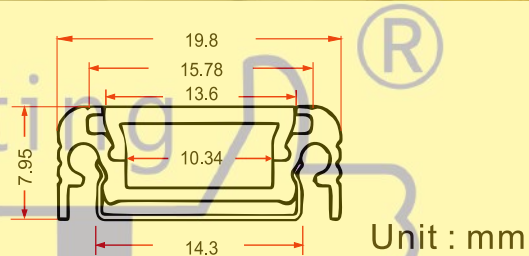

Features 產品特點>>

- ★ PC cover : milky
- ★ Size: 19.8mm (W) x 7.95 mm (H)
- ★ SPM Design – power circuit protection to cut off individual LEDs when mal-functioned
- ★ Aluminum to maximize heat dissipation
- ★ Installation in serial for seamless lighting output
- ★ Uniform light emission without LED spot
- ★ Application: Kitchen cabinet, Bathroom cabinet ,Closet, Show cabinet, Retail shop,etc

- ★ PC蓋:乳白色
- ★ 尺寸:19.8毫米(寬)X7.95毫米(高)
- ★ 使用SPM設計-電源電路保護,在故障時切斷單個LED
- ★ 採用鋁框架使散熱最大化
- ★ 串聯安裝以實現無縫照明輸出
- ★ 發光均勻,無LED光點
- ★ 應用:廚櫃、浴室櫃、壁櫥、展示櫃、零售店等

Specification 產品規格>>

Model 型號	DC Voltage 電壓	Wattage 功率	Length 長度	Lamp Life 光度壽命	Colour Temp 色溫	Lumen Output 輸出流明	Color Rendering 顯色度	Beam Angle 光速角度	Operating Temperature 工作溫度
	(V)	(W)	(mm)	(Hrs)	(K)	(Lm/W)	(CRI)	(°)	(°C)
CBL-A2008-S1004-109A	12/24	4	1000	30,000	2700/3000/4000/6500	100	>90	120	-20~+45
CBL-A2008-S1008-109A	12/24	8	1000	30,000	2700/3000/4000/6500	100	>90	120	-20~+45
CBL-A2008-S1205-109A	12/24	5	1200	30,000	2700/3000/4000/6500	100	>90	120	-20~+45
CBL-A2008-S1210-109A	12/24	10	1200	30,000	2700/3000/4000/6500	100	>90	120	-20~+45

Light efficiency (lm/W), Power (W), Color Rendering Index (CRI), Length Can be customized according to customer needs
 Our Standard Power factor (PF) > 0.9 and Total harmonic index THD < 15%, According to customer requirements can produce a lower THD < 10%
 This type of certification is issued by a government-approved laboratory for Safety certification, Fire testing, Restriction of Hazardous Substances (RoHS), Photobiological safety of lamps and lamp systems. (an Exemption Group) and other test certifications to ensure product quality

光效 (lm/W)、功率 (W)、顯色指數 (CRI)、長度, 可根據客戶需求定制
 此型號標準之功率因素 (PF) > 0.9, 總諧波指數 THD < 15%, 可按客戶需要生產低總諧波指數 < 10%
 此型號認證由可實驗室發出之安全認證消防測試, 環保物料 (RoHS), 光生物安全為 Exemption Group 及其它測試, 保證客戶使用更安心滿意



東權 LED 照明公司
EASTLIKE LED Co., Ltd

Office Address: Room B3, 18/F Bonsun Industrial Building, 364-366 Sha Tsui Road, Tsuen Wan, HongKong
 Phone: 852-39745593 Fax: 852-35440462 info@eastlike.com www.eastlike.com

Aluminum LED Strip

Series Type: C2310L



LED Lighting

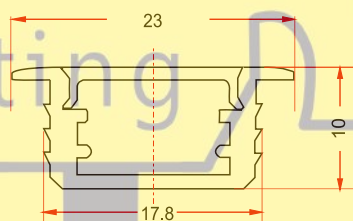

Unit : mm

Features 產品特點>>

- ★ Material: AIR6063 Aluminum
- ★ Size: 23mm (width) X10mm (height)
- ★ LED cold light source, pure light color, very good display effect
- ★ High light transmission, non-glare, natural light color, uniform light
- ★ High thermal conductivity aluminum-based PCB board, low heat generation and good heat dissipation
- ★ Suitable for cabinet, wardrobe, wine cabinet, display cabinet, lockers and other furniture lighting

- ★ 燈體材料: 航空6063鋁
- ★ 尺寸: 23毫米(寬)X10毫米(高)
- ★ LED冷光源, 光色純正, 非常好的展示效果
- ★ 高透光, 不刺眼, 光色自然, 光線均勻
- ★ 採用高導熱鋁基PCB板, 發熱量低, 散熱好
- ★ 適用於櫥櫃、衣櫃、酒櫃、展示櫃、儲物櫃等家具照明

Specification 產品規格>>

Model 型號	DC Voltage 電壓	Wattage 功率	Length 長度	Lamp Life 光度壽命	Colour Temp 色溫	Lumen Output 輸出流明	Color Rendering 顯色度	Beam Angle 光速角度	Operating Temperature 工作溫度
	(V)	(W)	(mm)	(Hrs)	(K)	(Lm/W)	(CRI)	(°)	(°C)
CBL-C2310L	12	12	1000	30,000	3000/4000/6000	100	>90	120	-20~+45

Light efficiency (lm/W), Power (W), Color Rendering Index (CRI), Length Can be customized according to customer needs
 Our Standard Power factor (PF) > 0.9 and Total harmonic index THD < 15%, According to customer requirements can produce a lower THD < 10%
 This type of certification is issued by a government-approved laboratory for Safety certification, Fire testing, Restriction of Hazardous Substances (RoHS), Photobiological safety of lamps and lamp systems. (an Exemption Group) and other test certifications to ensure product quality

光效 (lm/W)、功率 (W)、顯色指數 (CRI)、長度, 可根據客戶需求定制
 此型號標準之功率因素 (PF) > 0.9, 總諧波指數 THD < 15%, 可按客戶需要生產低總諧波指數 < 10%
 此型號認證由可實驗室發出之安全認證消防測試, 環保物料 (RoHS), 光生物安全為 Exemption Group 及其它測試, 保證客戶使用更安心滿意



東欄 LED 照明公司
EASTLIKE LED Co., Ltd

Office Address: Room B3, 18/F Bonsun Industrial Building, 364-366 Sha Tsui Road, Tsuen Wan, HongKong
 Phone: 852-39745593 Fax: 852-35440462 info@eastlike.com www.eastlike.com

Aluminum LED Strip

Series Type: C2408L



LED Lighting

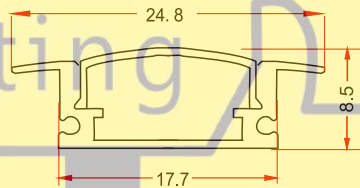

Unit : mm

Features 產品特點>>

- ★ Material: AIR6063 Aluminum
- ★ Size: 24.8mm (width) X 8.5mm (height)
- ★ Emitting arc lamp, a larger lighting surface
- ★ Light body is smooth, high brightness, lightweight and thin
- ★ UV resistance does not change yellow, high light transmission
- ★ Suitable for lighting of cabinets, wardrobe, wine cabinets, display cabinets, lockers and other furniture

- ★ 燈體材料：航空6063鋁
- ★ 尺寸：24.8毫米（寬）X 8.5毫米（高）
- ★ 微弧型發光罩，亮化面更大
- ★ 燈體光滑，亮度高，輕質超薄
- ★ 抗UV紫外線不變黃，高透光
- ★ 適用於櫥櫃，衣櫃，酒櫃，展示櫃，儲物櫃等家具照明

Specification 產品規格>>

Model 型號	DC Voltage 電壓	Wattage 功率	Length 長度	Lamp Life 光度壽命	Colour Temp 色溫	Lumen Output 輸出流明	Color Rendering 顯色度	Beam Angle 光速角度	Operating Temperature 工作溫度
	(V)	(W)	(mm)	(Hrs)	(K)	(Lm/W)	(CRI)	(°)	(°C)
CBL-C2408L	12	12	1000	30,000	3000/4000/6000	100	>90	120	-20~+45

Light efficiency (lm/W), Power (W), Color Rendering Index (CRI), Length Can be customized according to customer needs
Our Standard Power factor (PF) > 0.9 and Total harmonic index THD < 15%, According to customer requirements can produce a lower THD < 10%
This type of certification is issued by a government-approved laboratory for Safety certification, Fire testing, Restriction of Hazardous Substances (RoHS), Photobiological safety of lamps and lamp systems. (an Exemption Group) and other test certifications to ensure product quality

光效 (lm/W)、功率 (W)、顯色指數 (CRI)、長度，可根據客戶需求定制
此型號標準之功率因素 (PF) > 0.9, 總諧波指數 THD < 15%, 可按客戶需要生產低總諧波指數 < 10%
此型號認證由可實驗室發出之安全認證消防測試, 環保物料 (RoHS), 光生物安全為 Exemption Group 及其它測試, 保證客戶使用更安心滿意



東權 LED 照明公司
EASTLIKE LED Co., Ltd

Office Address: Room B3, 18/F Bonsun Industrial Building, 364-366 Sha Tsui Road, Tsuen Wan, HongKong
Phone: 852-39745593 Fax: 852-35440462 info@eastlike.com www.eastlike.com

Aluminum LED Strip

Series Type: C1712



LED Lighting

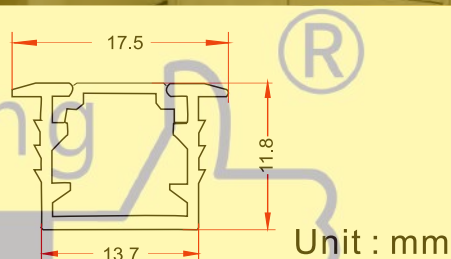

Features 產品特點>>

- ★ Material: AIR6063 Aluminum
 - ★ Size: 17.5mm (width) X 11.8mm (height)
 - ★ Round plugs, flat plugs, multi-color aluminum, more perfect with furniture decoration
 - ★ Even light, no dark area, the first choice for cabinet lighting
 - ★ The surface of the whole lamp is anodized, which is more durable, and the lamp body is jagged, which is more secure
 - ★ Suitable for furniture lighting such as cabinets, wardrobes, wine cabinets, display cabinets, storage cabinets, etc
- ★ 燈體材料: 航空6063鋁
 - ★ 尺寸: 17.5毫米(寬) X 11.8毫米(高)
 - ★ 圓堵頭, 平堵頭, 多色鋁材, 更完美搭配家具裝飾
 - ★ 發光均勻, 無暗區, 櫃內燈光首選
 - ★ 整燈表面陽極氧化, 更耐用, 燈體呈鋸齒狀, 安裝更牢固
 - ★ 適用於櫥櫃, 衣櫃, 酒櫃, 展示櫃, 儲物櫃等家具照明

Specification 產品規格>>

Model 型號	DC Voltage 電壓	Wattage 功率	Length 長度	Lamp Life 光度壽命	Colour Temp 色溫	Lumen Output 輸出流明	Color Rendering 顯色度	Beam Angle 光速角度	Operating Temperature 工作溫度
	(V)	(W)	(mm)	(Hrs)	(K)	(Lm/W)	(CRI)	(°)	(°C)
CBL-C1712L	12	8	1000	30,000	3000/4000/6000	100	>90	120	-20~+45

Light efficiency (lm/W), Power (W), Color Rendering Index (CRI), Length Can be customized according to customer needs
 Our Standard Power factor (PF) > 0.9 and Total harmonic index THD < 15%, According to customer requirements can produce a lower THD < 10%
 This type of certification is issued by a government-approved laboratory for Safety certification, Fire testing, Restriction of Hazardous Substances (RoHS), Photobiological safety of lamps and lamp systems. (an Exemption Group) and other test certifications to ensure product quality

光效 (lm/W)、功率 (W)、顯色指數 (CRI)、長度, 可根據客戶需求定制
 此型號標準之功率因素 (PF) > 0.9, 總諧波指數 THD < 15%, 可按客戶需要生產低總諧波指數 < 10%
 此型號認證由可實驗室發出之安全認證消防測試, 環保物料 (RoHS), 光生物安全為 Exemption Group 及其它測試, 保證客戶使用更安心滿意



東欄 LED 照明公司
EASTLIKE LED Co., Ltd

Office Address: Room B3, 18/F Bonsun Industrial Building, 364-366 Sha Tsui Road, Tsuen Wan, HongKong
 Phone: 852-39745593 Fax: 852-35440462 info@eastlike.com www.eastlike.com

5050 Light Belt Monochrome

Series Type: SLB-S

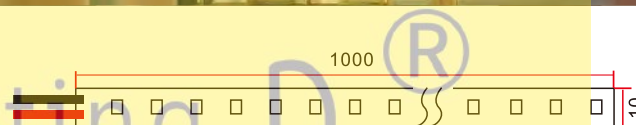
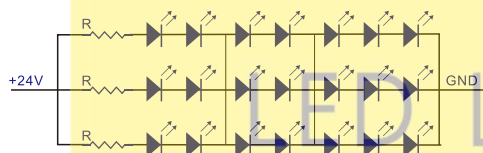
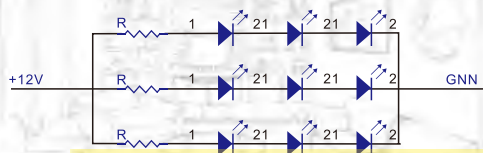

Unit : mm

Features 產品特點>>

- ★ High brightness patch 5050 LED is adopted as the light source with high brightness and wide Angle of view
- ★ The base plate adopts double-sided imported calender copper FPC, which has good folding resistance and strong over-current capacity
- ★ LED Nos: 60PCS/M
- ★ Ultra-low power consumption, only 0.6 watts per unit
- ★ Reasonable optical design, without flicker
- ★ Suitable for indoor installation
- ★ 採用高亮度貼片5050 LED作為高亮度寬視角光源
- ★ 底板採用雙面進口壓延銅FPC, 抗折性好, 過電流能力強
- ★ LED數量:60PCS/M
- ★ 超低功耗, 每臺僅0.6瓦
- ★ 光學設計合理, 無光斑, 無頻閃
- ★ 適用於室內安裝

Specification 產品規格>>

Model 型號	DC Voltage 電壓	Wattage 功率	Lamp Life 光度壽命	Colour Temp 色溫	Lumen Output 輸出流明	Color Rendering 顯色度	Length Per Roll 每卷長度	Size 尺寸
	(V)	(W/M)	(Hrs)	(K)	(Lm/W)	(CRI)	(M)	(mm)
SLB-S5050	12~24	14	30,000	3000	80	>80	5	10*6

Light efficiency (lm/W), Power (W), Color Rendering Index (CRI), Length Can be customized according to customer needs

Our Standard Power factor (PF) > 0.9 and Total harmonic index THD < 15%, According to customer requirements can produce a lower THD < 10%

This type of certification is issued by a government-approved laboratory for Safety certification, Fire testing, Restriction of Hazardous Substances (RoHS), Photobiological safety of lamps and lamp systems. (an Exemption Group) and other test certifications to ensure product quality

光效 (lm/W)、功率 (W)、顯色指數 (CRI)、長度, 可根據客戶需求定制

此型號標準之功率因素 (PF) > 0.9, 總諧波指數 THD < 15%, 可按客戶需要生產低總諧波指數 < 10%

此型號認證由可實驗室發出之安全認證消防測試, 環保物料 (RoHS), 光生物安全為 Exemption Group 及其它測試, 保證客戶使用更安心滿意



東權 LED 照明公司
EASTLIKE LED Co., Ltd

Office Address: Room B3, 18/F Bonsun Industrial Building, 364-366 Sha Tsui Road, Tsuen Wan, HongKong
Phone: 852-39745593 Fax: 852-35440462 info@eastlike.com www.eastlike.com

Glue Waterproof

Series Type: SLB-IP

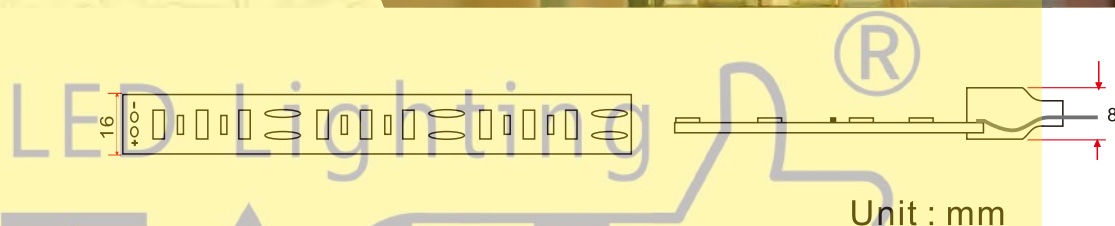

Features 產品特點>>

- ★ High brightness patch 2835 LED is adopted as the light source with high brightness and wide Angle of view
 - ★ The base plate adopts double-sided imported calender copper PVC
 - ★ LED Nos: 120PCS/M
 - ★ Beam angle:120°
 - ★ Ultra-low power consumption, only 0.6 watts per unit
 - ★ Reasonable optical design, without flicker
 - ★ Good waterproof, suitable for indoor and outdoor installation
- ★ 採用高亮度貼片2835LED作為高亮度寬視角光源
 - ★ 底板採用雙面進口壓PVC
 - ★ LED數量:120PCS / M
 - ★ 光束角度120度
 - ★ 超低功耗,每臺僅0.6瓦
 - ★ 光學設計合理,無光斑,無頻閃
 - ★ 防水性好,適用於室內和室外安裝

Specification 產品規格>>

Model 型號	DC Voltage 電壓	Wattage 功率	Lamp Life 光度壽命	Colour Temp 色溫	Lumen Output 輸出流明	Color Rendering 顯色度	Length Per Roll 每卷長度	Size 尺寸
	(V)	(W/M)	(Hrs)	(K)	(Lm/W)	(CRI)	(M)	(mm)
SLB-IP2835	12	14	30,000	3000/4000/6500	100	>80	1	16*8

Light efficiency (lm/W), Power (W), Color Rendering Index (CRI), Length Can be customized according to customer needs
 Our Standard Power factor (PF) > 0.9 and Total harmonic index THD < 15%, According to customer requirements can produce a lower THD < 10%
 This type of certification is issued by a government-approved laboratory for Safety certification, Fire testing, Restriction of Hazardous Substances (RoHS), Photobiological safety of lamps and lamp systems. (an Exemption Group) and other test certifications to ensure product quality

光效 (lm/W)、功率 (W)、顯色指數 (CRI)、長度, 可根據客戶需求定制
 此型號標準之功率因素 (PF) > 0.9, 總諧波指數 THD < 15%, 可按客戶需要生產低總諧波指數 < 10%
 此型號認證由可實驗室發出之安全認證消防測試, 環保物料 (RoHS), 光生物安全為 Exemption Group 及其它測試, 保證客戶使用更安心滿意



東樞 LED 照明公司
EASTLIKE LED Co., Ltd

Office Address: Room B3, 18/F Bonsun Industrial Building, 364-366 Sha Tsui Road, Tsuen Wan, HongKong
 Phone: 852-39745593 Fax: 852-35440462 info@eastlike.com www.eastlike.com

RGB Waterproofing

Series Type: SLB-RGB-IP

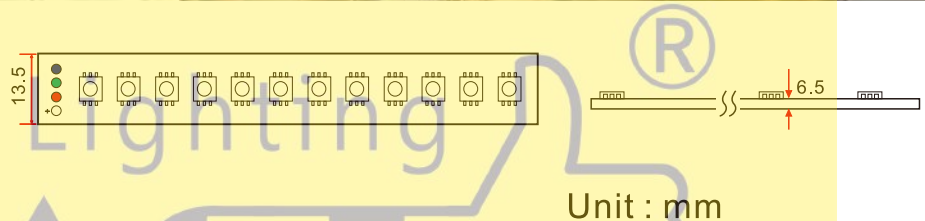

Features 產品特點>>

- ★ High brightness patch 2835 LED is adopted as the light source with high brightness and wide Angle of view
 - ★ The base plate adopts double-sided imported calender copper PVC, very good resistance
 - ★ LED Nos: 60PCS/M
 - ★ Beam angle:120°
 - ★ Ultra-low power consumption, only 0.6 watts per unit
 - ★ Reasonable optical design, without flicker
 - ★ Easy installation with aluminium trough
 - ★ Good waterproof, suitable for indoor and outdoor installation
- ★ 採用高亮度貼片2835LED作為高亮度寬視角光源
 - ★ 底板採用雙面進口壓PVC,耐性非常好
 - ★ LED數量: 60PCS/M
 - ★ 光束角度: 120°
 - ★ 超低功耗, 每臺僅0.6瓦
 - ★ 光學設計合理, 無光斑, 無頻閃
 - ★ 鋁槽安裝方便
 - ★ 防水性好, 適用於室內和室外安裝

Specification 產品規格>>

Model 型號	DC Voltage 電壓	Wattage 功率	Lamp Life 光度壽命	Colour Temp 色溫	Lumen Output 輸出流明	Color Rendering 顯色度	Length Per Roll 每卷長度	Size 尺寸
	(V)	(W/M)	(Hrs)	(K)	(Lm/W)	(CRI)	(M)	(mm)
SLB-RGB-IP5050	220~240	13.5	30,000	RGB	100	>80	5	13.5*6.5

Light efficiency (lm/W), Power (W), Color Rendering Index (CRI), Length Can be customized according to customer needs
 Our Standard Power factor (PF) > 0.9 and Total harmonic index THD < 15%, According to customer requirements can produce a lower THD < 10%
 This type of certification is issued by a government-approved laboratory for Safety certification, Fire testing, Restriction of Hazardous Substances (RoHS), Photobiological safety of lamps and lamp systems. (an Exemption Group) and other test certifications to ensure product quality

光效 (lm/W)、功率 (W)、顯色指數 (CRI)、長度, 可根據客戶需求定制
 此型號標準之功率因素 (PF) > 0.9, 總諧波指數 THD < 15%, 可按客戶需要生產低總諧波指數 < 10%
 此型號認證由可實驗室發出之安全認證消防測試, 環保物料 (RoHS), 光生物安全為 Exemption Group 及其它測試, 保證客戶使用更安心滿意



東權 LED 照明公司
EASTLIKE LED Co., Ltd

Office Address: Room B3, 18/F Bonsun Industrial Building, 364-366 Sha Tsui Road, Tsuen Wan, HongKong
 Phone: 852-39745593 Fax: 852-35440462 info@eastlike.com www.eastlike.com

Double Color

Series Type: SLB-D-IP

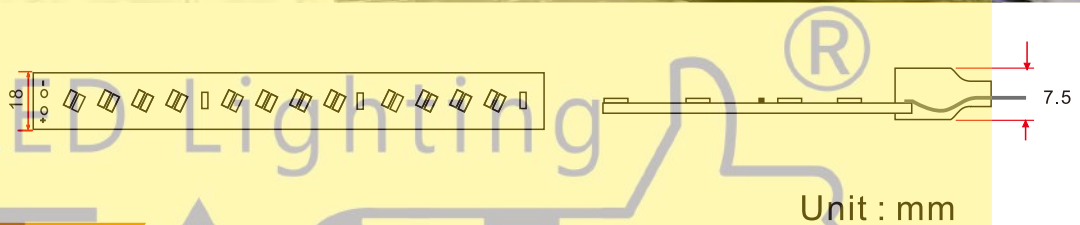

Features 產品特點>>

- ★ High brightness patch 2835 LED is adopted as the light source with high brightness and wide Angle of view
 - ★ The base plate adopts double-sided imported calender copper PVC, very good resistance
 - ★ LED Nos: 120PCS/M
 - ★ Beam angle:120°
 - ★ Ultra-low power consumption, only 0.6 watts per unit
 - ★ Reasonable optical design, without flicker
 - ★ Easy installation with aluminium trough
 - ★ Good waterproof, suitable for indoor and outdoor installation
- ★ 採用高亮度貼片2835LED作為高亮度寬視角光源
 - ★ 底板採用雙面進口壓PVC,耐性非常好
 - ★ LED數量: 120PCS/M
 - ★ 光束角度: 120°
 - ★ 超低功耗, 每臺僅0.6瓦
 - ★ 光學設計合理, 無光斑, 無頻閃
 - ★ 鋁槽安裝方便
 - ★ 防水性好, 適用於室內和室外安裝

Specification 產品規格>>

Model 型號	DC Voltage 電壓	Wattage 功率	Lamp Life 光度壽命	Colour Temp 色溫	Lumen Output 輸出流明	Color Rendering 顯色度	Length Per Roll 每卷長度	Size 尺寸
	(V)	(W/M)	(Hrs)	(K)	(Lm/W)	(CRI)	(M)	(mm)
SLB-D-IP5630	220~240	13.5	30,000	2700~6500	100-140	>80	5	18*7.5

Light efficiency (lm/W), Power (W), Color Rendering Index (CRI), Length Can be customized according to customer needs
 Our Standard Power factor (PF) > 0.9 and Total harmonic index THD < 15%, According to customer requirements can produce a lower THD < 10%
 This type of certification is issued by a government-approved laboratory for Safety certification, Fire testing, Restriction of Hazardous Substances (RoHS), Photobiological safety of lamps and lamp systems. (an Exemption Group) and other test certifications to ensure product quality

光效 (lm/W)、功率 (W)、顯色指數 (CRI)、長度, 可根據客戶需求定制
 此型號標準之功率因素 (PF) > 0.9, 總諧波指數 THD < 15%, 可按客戶需要生產低總諧波指數 < 10%
 此型號認證由可實驗室發出之安全認證消防測試, 環保物料 (RoHS), 光生物安全為 Exemption Group 及其它測試, 保證客戶使用更安心滿意



東樞 LED 照明公司
EASTLIKE LED Co., Ltd

Office Address: Room B3, 18/F Bonsun Industrial Building, 364-366 Sha Tsui Road, Tsuen Wan, HongKong
 Phone: 852-39745593 Fax: 852-35440462 info@eastlike.com www.eastlike.com

IP65 Hollow Light Belt

Series Type: SLB-T-65



Transparent

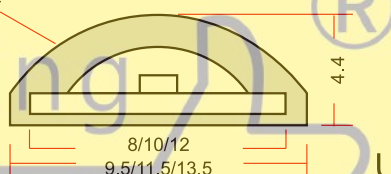

Unit : mm

Features 產品特點>>

- ★ Silica gel material, very good resistance
- ★ Light transmittance of more than 90%, high tensile strength, tensile rate of 500%
- ★ High brightness patch 5050 LED is adopted as the light
- ★ Hollow design, color temperature control within 3%
- ★ Reasonable optical design, without flicker
- ★ The luminous surface is arc-shaped, the luminous angle is good, and the plane illuminance curve is good
- ★ Suitable for indoor or semi-outdoor trough

- ★ 矽膠材質, 耐候性非常好
- ★ 透光率90%以上, 抗拉强度高, 拉伸速率500%
- ★ 採用高亮度貼片5050 LED作為光源
- ★ 鏤空設計, 色溫控制3%以內
- ★ 光學設計合理, 無光斑, 無頻閃
- ★ 發光面弧形, 發光角度好, 平面照度曲線好
- ★ 適用於室內或者半戶外

Specification 產品規格>>

Model 型號	DC Voltage 電壓 (V)	Wattage 功率 (W/M)	Lamp Life 光度壽命 (Hrs)	Colour Temp 色溫 (K)	Lumen Output 輸出流明 (Lm/W)	Total Lumen 總流明 (Lm/M)	Color Rendering 顯色度 (CRI)	Suitable Plate Width 適宜板寬 (mm)	Size 尺寸 (mm)
SLB-T1004-65	12/24	9.6/4.8	30,000	3000	100	960 / 480	>80	8	9.5*4.4
SLB-T1204-65	12/24	9.6/4.8	30,000	3000	100	960 / 480	>80	10	11.5*4.4
SLB-T1404-65	12/24	9.6/4.8	30,000	3000	100	960 / 480	>80	12	13.5*4.4

Light efficiency (lm/W), Power (W), Color Rendering Index (CRI), Length Can be customized according to customer needs
 Our Standard Power factor (PF) > 0.9 and Total harmonic index THD < 15%, According to customer requirements can produce a lower THD < 10%
 This type of certification is issued by a government-approved laboratory for Safety certification, Fire testing, Restriction of Hazardous Substances (RoHS), Photobiological safety of lamps and lamp systems. (an Exemption Group) and other test certifications to ensure product quality

光效 (lm/W)、功率 (W)、顯色指數 (CRI)、長度, 可根據客戶需求定制
 此型號標準之功率因素 (PF) > 0.9, 總諧波指數 THD < 15%, 可按客戶需要生產低總諧波指數 < 10%
 此型號認證由可實驗室發出之安全認證消防測試, 環保物料 (RoHS), 光生物安全為 Exemption Group 及其它測試, 保證客戶使用更安心滿意



東權 LED 照明公司
EASTLIKE LED Co., Ltd

Office Address: Room B3, 18/F Bonsun Industrial Building, 364-366 Sha Tsui Road, Tsuen Wan, HongKong
 Phone: 852-39745593 Fax: 852-35440462 info@eastlike.com www.eastlike.com

IP67 Hollow Light Belt

Series Type: SLB-T-67



Transparent

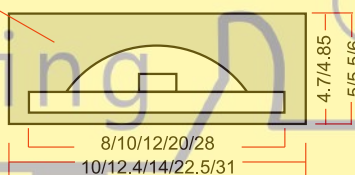

Unit : mm

Features 產品特點>>

- ★ Silica gel material, very good resistance
- ★ Light transmittance of more than 90%, high tensile strength, tensile rate of 500%
- ★ High brightness patch 5050 LED is adopted as the light
- ★ Hollow design, better heat dissipation
- ★ Reasonable optical design, without flicker
- ★ The luminous surface is square, the luminous angle is good, and the plane illuminance curve is good
- ★ Suitable for indoor or outdoor non-deep water
- ★ 矽膠材質, 耐候性常好
- ★ 透光率90%以上, 抗拉强度高, 拉伸速率500%
- ★ 採用高亮度贴片5050 LED作為光源
- ★ 鑲空設計, 散熱性好
- ★ 光學設計合理, 無光斑, 無頻閃
- ★ 發光面正面, 發光角度好, 平面照度曲線好
- ★ 適用於室內或者室外非深水處

Specification 產品規格>>

Model 型號	DC Voltage 電壓	Wattage 功率	Lamp Life 光度壽命	Colour Temp 色溫	Lumen Output 輸出流明	Total Lumen 總流明	Color Rendering 顯色度	Suitable Plate Width 適宜板寬	Size 尺寸
	(V)	(W/M)	(Hrs)	(K)	(Lm/W)	(Lm/M)	(CRI)	(mm)	(mm)
SLB-T1005-67	12/24	9.6/4.8	30,000	3000	100	960 / 480	>80	8	10*4.7
SLB-T1205-67	12/24	9.6/4.8	30,000	3000	100	960 / 480	>80	10	12*4.85
SLB-T1405-67	12/24	9.6/4.8	30,000	3000	100	960 / 480	>80	12	14*5
SLB-T2206-67	12/24	9.6/4.8	30,000	3000	100	960 / 480	>80	20	22*5.5
SLB-T3106-67	12/24	9.6/4.8	30,000	3000	100	960 / 480	>80	28	31*6

Light efficiency (lm/W), Power (W), Color Rendering Index (CRI), Length Can be customized according to customer needs
Our Standard Power factor (PF) > 0.9 and Total harmonic index THD < 15%, According to customer requirements can produce a lower THD < 10%

This type of certification is issued by a government-approved laboratory for Safety certification, Fire testing, Restriction of Hazardous Substances (RoHS), Photobiological safety of lamps and lamp systems. (an Exemption Group) and other test certifications to ensure product quality

光效 (lm/W)、功率 (W)、顯色指數 (CRI)、長度, 可根據客戶需求定制

此型號標準之功率因素 (PF) > 0.9, 總諧波指數 THD < 15%, 可按客戶需要生產低總諧波指數 < 10%

此型號認證由可實驗室發出之安全認證消防測試, 環保物料 (RoHS), 光生物安全為 Exemption Group 及其它測試, 保證客戶使用更安心滿意



東攏 LED 照明公司
EASTLIKE LED Co., Ltd

Office Address: Room B3, 18/F Bonsun Industrial Building, 364-366 Sha Tsui Road, Tsuen Wan, HongKong
Phone: 852-39745593 Fax: 852-35440462 info@eastlike.com www.eastlike.com

T5 Series Neon Light

Series Type: SLB-NL-T5

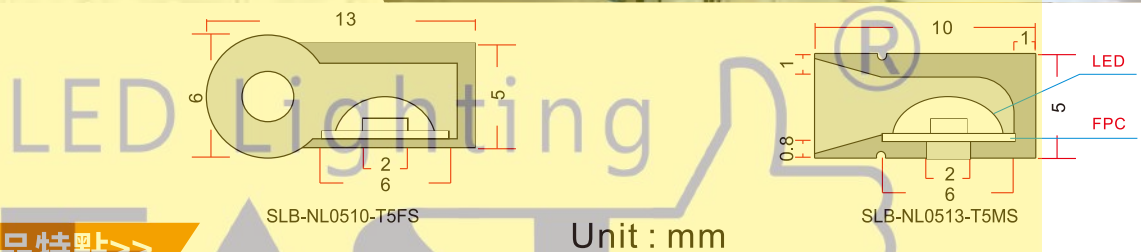

Features 產品特點>>

- ★ High brightness patch 2835 LED is adopted as the light source with high brightness and wide Angle of view
- ★ Silicone material, very good weather resistance
- ★ LED Nos: 120PCS/M
- ★ Hollow design, good heat dissipation
- ★ Can be arbitrarily cropped
- ★ The special design of the plug is convenient for shape docking, and there is no dark area in docking
- ★ The light strip is very soft, convenient for packaging and any shape
- ★ Suitable for indoor and outdoor

- ★ 採用高亮度貼片2835LED作為高亮度寬視角光源
- ★ 硅胶材質,耐候性非常好
- ★ LED數量: 120PCS/M
- ★ 鏤空設計,散熱性好
- ★ 可以任意裁剪
- ★ 堵頭特殊設計,方便造型對接,對接無暗區
- ★ 燈帶非常柔軟,方便包裝以及任意造型
- ★ 适用于室內室外

Unit : mm

Specification 產品規格>>

Model 型號	DC Voltage 電壓	Wattage 功率	Lamp Life 光度壽命	Colour Temp 色溫	Lumen Output 輸出流明	Total Lumen 總流明	Color Rendering 顯色度	Waterproof Grade 防水等級	Size 尺寸
	(V)	(W/M)	(Hrs)	(K)	(Lm/W)	(Lm/M)	(CRI)	(IP)	(mm)
SLB-NL0510-T5FS	12/24	9.6/4.8	30,000	3000	100	960 / 480	>80	IP67	5*10
SLB-NL0513-T5MS	12/24	9.6/4.8	30,000	3000	100	960 / 480	>80	IP67	5*13

Light efficiency (lm/W), Power (W), Color Rendering Index (CRI), Length Can be customized according to customer needs
Our Standard Power factor (PF) > 0.9 and Total harmonic index THD < 15%, According to customer requirements can produce a lower THD < 10%
This type of certification is issued by a government-approved laboratory for Safety certification, Fire testing, Restriction of Hazardous Substances (RoHS), Photobiological safety of lamps and lamp systems, (an Exemption Group) and other test certifications to ensure product quality

光效 (lm/W)、功率 (W)、顯色指數 (CRI)、長度, 可根據客戶需求定制
此型號標準之功率因素 (PF) > 0.9, 總諧波指數 THD < 15%, 可按客戶需要生產低總諧波指數 < 10%
此型號認證由可實驗室發出之安全認證消防測試, 環保物料 (RoHS), 光生物安全為 Exemption Group 及其它測試, 保證客戶使用更安心滿意



東權 LED 照明公司
EASTLIKE LED Co., Ltd

Office Address: Room B3, 18/F Bonsun Industrial Building, 364-366 Sha Tsui Road, Tsuen Wan, HongKong
Phone: 852-39745593 Fax: 852-35440462 info@eastlike.com www.eastlike.com

T10 Series Neon Light

Series Type: SLB-NL-T10

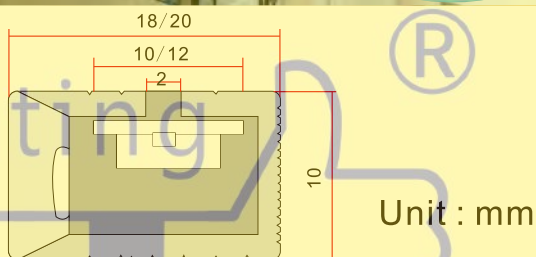

Unit : mm

Features 產品特點>>

- ★ High brightness patch 2835 LED is adopted as the light source with high brightness and wide Angle of view
 - ★ Silicone material, very good weather resistance
 - ★ LED Nos: 60PCS/M
 - ★ Hollow design, good heat dissipation
 - ★ Can be arbitrarily cropped
 - ★ The special design of the plug is convenient for shape docking, and there is no dark area in docking
 - ★ The light strip is very soft, convenient for packaging and any shape
 - ★ Suitable for indoor and outdoor
- ★ 採用高亮度贴片2835LED作為高亮度寬視角光源
 - ★ 硅胶材質,耐候性非常好
 - ★ LED數量: 60PCS/M
 - ★ 鏤空設計,散熱性好
 - ★ 可以任意裁剪
 - ★ 堵頭特殊設計,方便造型對接,對接無暗區
 - ★ 燈帶非常柔軟,方便包裝以及任意造型
 - ★ 适用于室內室外

Specification 產品規格>>

Model 型號	DC Voltage 電壓	Wattage 功率	Lamp Life 光度壽命	Colour Temp 色溫	Lumen Output 輸出流明	Total Lumen 總流明	Color Rendering 顯色度	Suitable Plate Width 適宜板寬	Size 尺寸
	(V)	(W/M)	(Hrs)	(K)	(Lm/W)	(Lm/M)	(CRI)	(mm)	(mm)
SLB-NL1018-T10FS	12/24	9.6	30,000	3000	100	960	>80	IP67	10*18
SLB-NL1020-T10FS	12/24	9.6	30,000	3000	100	960	>80	IP67	10*20

Light efficiency (lm/W), Power (W), Color Rendering Index (CRI), Length Can be customized according to customer needs
 Our Standard Power factor (PF) > 0.9 and Total harmonic index THD < 15%, According to customer requirements can produce a lower THD < 10%
 This type of certification is issued by a government-approved laboratory for Safety certification, Fire testing, Restriction of Hazardous Substances (RoHS), Photobiological safety of lamps and lamp systems. (an Exemption Group) and other test certifications to ensure product quality

光效 (lm/W)、功率 (W)、顯色指數 (CRI)、長度, 可根據客戶需求定制
 此型號標準之功率因素 (PF) > 0.9, 總諧波指數 THD < 15%, 可按客戶需要生產低總諧波指數 < 10%
 此型號認證由實驗室發出之安全認證消防測試, 環保物料 (RoHS), 光生物安全為 Exemption Group 及其它測試, 保證客戶使用更安心滿意



東樞 LED 照明公司
EASTLIKE LED Co., Ltd

Office Address: Room B3, 18/F Bonsun Industrial Building, 364-366 Sha Tsui Road, Tsuen Wan, HongKong
 Phone: 852-39745593 Fax: 852-35440462 info@eastlike.com www.eastlike.com

T10 Series Neon Light

Series Type: SLB-NL-T10

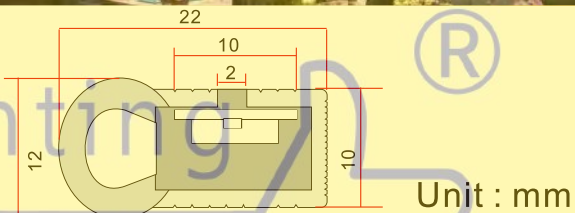
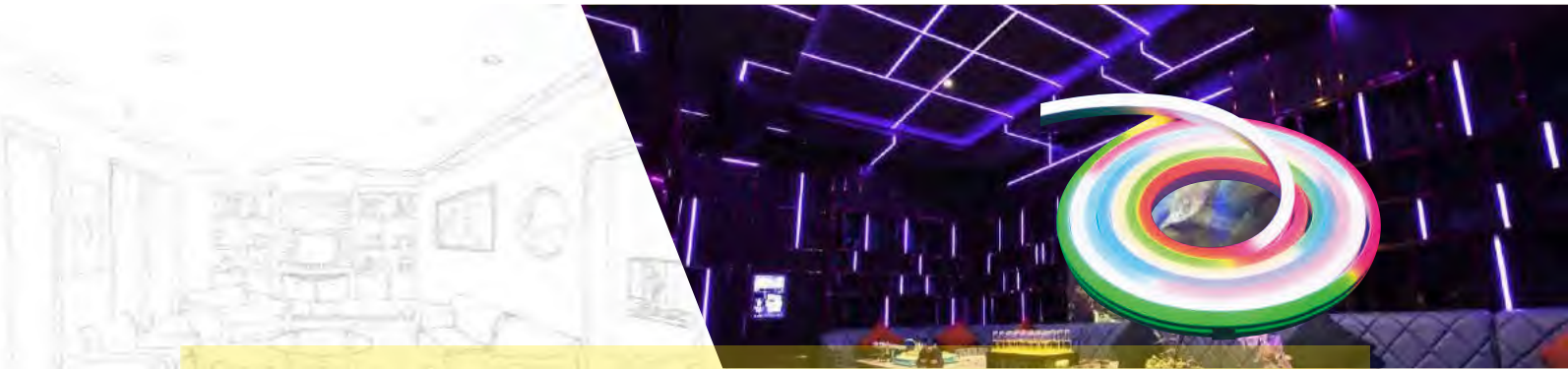

Features 產品特點>>

- ★ High brightness patch 2835 LED is adopted as the light source with high brightness and wide Angle of view
- ★ Silicone material, very good weather resistance
- ★ LED Nos: 60PCS/M
- ★ Hollow design, good heat dissipation
- ★ Can be arbitrarily cropped
- ★ The special design of the plug is convenient for shape docking, and there is no dark area in docking
- ★ The light strip is very soft, convenient for packaging and any shape
- ★ Suitable for indoor and outdoor

- ★ 採用高亮度貼片2835LED作為高亮度寬視角光源
- ★ 硅胶材質, 耐候性非常好
- ★ LED數量: 60PCS/M
- ★ 鏤空設計, 散熱性好
- ★ 可以任意裁剪
- ★ 堵頭特殊設計, 方便造型對接, 對接無暗區
- ★ 燈帶非常柔軟, 方便包裝以及任意造型
- ★ 适用于室內室外

Specification 產品規格>>

Model 型號	DC Voltage 電壓	Wattage 功率	Lamp Life 光度壽命	Colour Temp 色溫	Lumen Output 輸出流明	Total Lumen 總流明	Color Rendering 顯色度	Waterproof Grade 防水等級	Size 尺寸
	(V)	(W/M)	(Hrs)	(K)	(Lm/W)	(Lm/M)	(CRI)	(IP)	(mm)
SLB-NL1022-T10MS	12/24	9.6	30,000	3000	100	960	>80	IP67	12*22

Light efficiency (lm/W), Power (W), Color Rendering Index (CRI), Length Can be customized according to customer needs
 Our Standard Power factor (PF) > 0.9 and Total harmonic index THD < 15%, According to customer requirements can produce a lower THD < 10%
 This type of certification is issued by a government-approved laboratory for Safety certification, Fire testing, Restriction of Hazardous Substances (RoHS), Photobiological safety of lamps and lamp systems. (an Exemption Group) and other test certifications to ensure product quality

光效 (lm/W)、功率 (W)、顯色指數 (CRI)、長度, 可根據客戶需求定制
 此型號標準之功率因素 (PF) > 0.9, 總諧波指數 THD < 15%, 可按客戶需要生產低總諧波指數 < 10%
 此型號認證由可實驗室發出之安全認證消防測試, 環保物料 (RoHS), 光生物安全為 Exemption Group 及其它測試, 保證客戶使用更安心滿意



東權 LED 照明公司
EASTLIKE LED Co., Ltd

Office Address: Room B3, 18/F Bonsun Industrial Building, 364-366 Sha Tsui Road, Tsuen Wan, HongKong
 Phone: 852-39745593 Fax: 852-35440462 info@eastlike.com www.eastlike.com

T10 Series Neon Light

Series Type: SLB-NL-T10



LED Lighting

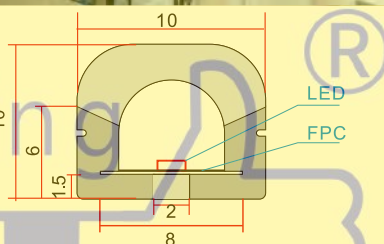

Unit : mm

Features 產品特點>>

- ★ High brightness patch 2835 LED is adopted as the light source with high brightness and wide Angle of view
- ★ Silicone material, very good weather resistance
- ★ LED Nos: 60PCS/M
- ★ Hollow design, good heat dissipation
- ★ Can be arbitrarily cropped
- ★ The special design of the plug is convenient for shape docking, and there is no dark area in docking
- ★ The light strip is very soft, convenient for packaging and any shape
- ★ Suitable for indoor and outdoor

- ★ 採用高亮度貼片2835LED作為高亮度寬視角光源
- ★ 硅胶材質,耐候性非常好
- ★ LED數量: 60PCS/M
- ★ 鏤空設計,散熱性好
- ★ 可以任意裁剪
- ★ 堵頭特殊設計,方便造型對接,對接無暗區
- ★ 燈帶非常柔軟,方便包裝以及任意造型
- ★ 适用于室內室外

Specification 產品規格>>

Model 型號	DC Voltage 電壓	Wattage 功率	Lamp Life 光度壽命	Colour Temp 色溫	Lumen Output 輸出流明	Total Lumen 總流明	Color Rendering 顯色度	Suitable Plate Width 適宜板寬	Size 尺寸
	(V)	(W/M)	(Hrs)	(K)	(Lm/W)	(Lm/M)	(CRI)	(mm)	(mm)
SLB-NL1010-T10FF	12/24	9.6	30,000	3000	100	960	>80	IP67	10*10

Light efficiency (lm/W), Power (W), Color Rendering Index (CRI), Length Can be customized according to customer needs

Our Standard Power factor (PF) > 0.9 and Total harmonic index THD < 15%, According to customer requirements can produce a lower THD < 10%

This type of certification is issued by a government-approved laboratory for Safety certification, Fire testing, Restriction of Hazardous Substances (RoHS), Photobiological safety of lamps and lamp systems. (an Exemption Group) and other test certifications to ensure product quality

光效 (lm/W)、功率 (W)、顯色指數 (CRI)、長度, 可根據客戶需求定制

此型號標準之功率因素 (PF) > 0.9, 總諧波指數 THD < 15%, 可按客戶需要生產低總諧波指數 < 10%

此型號認證由實驗室發出之安全認證消防測試, 環保物料 (RoHS), 光生物安全為 Exemption Group 及其它測試, 保證客戶使用更安心滿意



東攏 LED 照明公司
EASTLIKE LED Co., Ltd

Office Address: Room B3, 18/F Bonsun Industrial Building, 364-366 Sha Tsui Road, Tsuen Wan, HongKong
Phone: 852-39745593 Fax: 852-35440462 info@eastlike.com www.eastlike.com

T15 Series Neon Light

Series Type: SLB-NL-T15



LED Lighting



Unit : mm

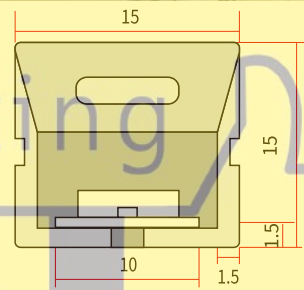

Features 產品特點>>

- ★ High brightness patch 2835 LED is adopted as the light source with high brightness and wide Angle of view
- ★ Silicone material, very good weather resistance
- ★ LED Nos: 120PCS/M
- ★ Hollow design, good heat dissipation
- ★ Can be arbitrarily cropped
- ★ The special design of the plug is convenient for shape docking, and there is no dark area in docking
- ★ The light strip is very soft, convenient for packaging and any shape
- ★ Suitable for indoor and outdoor

- ★ 採用高亮度貼片2835LED作為高亮度寬視角光源
- ★ 硅胶材質, 耐候性非常好
- ★ LED數量: 120PCS/M
- ★ 鏤空設計, 散熱性好
- ★ 可以任意裁剪
- ★ 堵頭特殊設計, 方便造型對接, 對接無暗區
- ★ 燈帶非常柔軟, 方便包裝以及任意造型
- ★ 适用于室內室外

Specification 產品規格>>

Model 型號	DC Voltage 電壓	Wattage 功率	Lamp Life 光度壽命	Colour Temp 色溫	Lumen Output 輸出流明	Total Lumen 總流明	Color Rendering 顯色度	Waterproof Grade 防水等級	Size 尺寸
	(V)	(W/M)	(Hrs)	(K)	(Lm/W)	(Lm/M)	(CRI)	(IP)	(mm)
SLB-NL1515-T15FF	12/24	9.6	30,000	3000	100	960	>80	IP67	15*15

Light efficiency (lm/W), Power (W), Color Rendering Index (CRI), Length Can be customized according to customer needs

Our Standard Power factor (PF) > 0.9 and Total harmonic index THD < 15%, According to customer requirements can produce a lower THD < 10%

This type of certification is issued by a government-approved laboratory for Safety certification, Fire testing, Restriction of Hazardous Substances (RoHS), Photobiological safety of lamps and lamp systems. (an Exemption Group) and other test certifications to ensure product quality

光效 (lm/W)、功率 (W)、顯色指數 (CRI)、長度, 可根據客戶需求定制

此型號標準之功率因素 (PF) > 0.9, 總諧波指數 THD < 15%, 可按客戶需要生產低總諧波指數 < 10%

此型號認證由可實驗室發出之安全認證消防測試, 環保物料 (RoHS), 光生物安全為 Exemption Group 及其它測試, 保證客戶使用更安心滿意



東權 LED 照明公司
EASTLIKE LED Co., Ltd

Office Address: Room B3, 18/F Bonsun Industrial Building, 364-366 Sha Tsui Road, Tsuen Wan, HongKong
Phone: 852-39745593 Fax: 852-35440462 info@eastlike.com www.eastlike.com

T15 Series Neon Light

Series Type: SLB-NL-T15



LED Lighting

Unit : mm

Features 產品特點>>

- ★ High brightness patch 2835 LED is adopted as the light source with high brightness and wide Angle of view
- ★ Silicone material, very good weather resistance
- ★ LED Nos: 120PCS/M
- ★ Hollow design, good heat dissipation
- ★ Can be arbitrarily cropped
- ★ The special design of the plug is convenient for shape docking, and there is no dark area in docking
- ★ The light strip is very soft, convenient for packaging and any shape
- ★ Suitable for indoor and outdoor

- ★ 採用高亮度貼片2835LED作為高亮度寬視角光源
- ★ 矽膠材質,耐候性非常好
- ★ LED數量: 120PCS/M
- ★ 鏤空設計,散熱性好
- ★ 可以任意裁剪
- ★ 堵頭特殊設計,方便造型對接,對接無暗區
- ★ 燈帶非常柔軟,方便包裝以及任意造型
- ★ 适用于室內室外

Specification 產品規格>>

Model 型號	DC Voltage 電壓	Wattage 功率	Lamp Life 光度壽命	Colour Temp 色溫	Lumen Output 輸出流明	Total Lumen 總流明	Color Rendering 顯色度	Waterproof Grade 防水等級	Size 尺寸
	(V)	(W/M)	(Hrs)	(K)	(Lm/W)	(Lm/M)	(CRI)	(IP)	(mm)
SLB-NL1515-T15FS	12/24	9.6	30,000	3000	100	960	>80	IP67	15*15

Light efficiency (lm/W), Power (W), Color Rendering Index (CRI), Length Can be customized according to customer needs
 Our Standard Power factor (PF) > 0.9 and Total harmonic index THD < 15%, According to customer requirements can produce a lower THD < 10%
 This type of certification is issued by a government-approved laboratory for Safety certification, Fire testing, Restriction of Hazardous Substances (RoHS), Photobiological safety of lamps and lamp systems. (an Exemption Group) and other test certifications to ensure product quality

光效 (lm/W)、功率 (W)、顯色指數 (CRI)、長度, 可根據客戶需求定制
 此型號標準之功率因素 (PF) > 0.9, 總諧波指數 THD < 15%, 可按客戶需要生產低總諧波指數 < 10%
 此型號認證由可實驗室發出之安全認證消防測試, 環保物料 (RoHS), 光生物安全為 Exemption Group 及其它測試, 保證客戶使用更安心滿意



東攏 LED 照明公司
EASTLIKE LED Co., Ltd

Office Address: Room B3, 18/F Bonsun Industrial Building, 364-366 Sha Tsui Road, Tsuen Wan, HongKong
 Phone: 852-39745593 Fax: 852-35440462 info@eastlike.com www.eastlike.com

T15 Series Neon Light

Series Type: SLB-NL-T15



LED Lighting

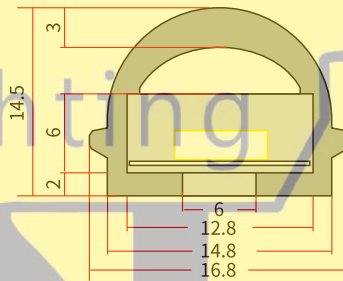

Unit : mm

Features 產品特點>>

- ★ High brightness patch 2835 LED is adopted as the light source with high brightness and wide Angle of view
- ★ Silicone material, very good weather resistance
- ★ LED Nos: 120PCS/M
- ★ Hollow design, good heat dissipation
- ★ Can be arbitrarily cropped
- ★ The special design of the plug is convenient for shape docking, and there is no dark area in docking
- ★ The light strip is very soft, convenient for packaging and any shape
- ★ Suitable for indoor and outdoor

- ★ 採用高亮度貼片2835LED作為高亮度寬視角光源
- ★ 硅胶材質, 耐候性非常好
- ★ LED數量: 120PCS/M
- ★ 鏤空設計, 散熱性好
- ★ 可以任意裁剪
- ★ 堵頭特殊設計, 方便造型對接, 對接無暗區
- ★ 燈帶非常柔軟, 方便包裝以及任意造型
- ★ 适用于室內室外

Specification 產品規格>>

Model 型號	DC Voltage 電壓	Wattage 功率	Lamp Life 光度壽命	Colour Temp 色溫	Lumen Output 輸出流明	Total Lumen 總流明	Color Rendering 顯色度	Waterproof Grade 防水等級	Size 尺寸
	(V)	(W/M)	(Hrs)	(K)	(Lm/W)	(Lm/M)	(CRI)	(IP)	(mm)
SLB-NL1715-T15MF	12/24	9.6	30,000	3000	100	960	>80	IP67	16.8*14.5

Light efficiency (lm/W), Power (W), Color Rendering Index (CRI), Length Can be customized according to customer needs

Our Standard Power factor (PF) > 0.9 and Total harmonic index THD < 15%, According to customer requirements can produce a lower THD < 10%

This type of certification is issued by a government-approved laboratory for Safety certification, Fire testing, Restriction of Hazardous Substances (RoHS), Photobiological safety of lamps and lamp systems. (an Exemption Group) and other test certifications to ensure product quality

光效 (lm/W)、功率 (W)、顯色指數 (CRI)、長度, 可根據客戶需求定制

此型號標準之功率因素 (PF) > 0.9, 總諧波指數 THD < 15%, 可按客戶需要生產低總諧波指數 < 10%

此型號認證由可實驗室發出之安全認證消防測試, 環保物料 (RoHS), 光生物安全為 Exemption Group 及其它測試, 保證客戶使用更安心滿意



東權 LED 照明公司
EASTLIKE LED Co., Ltd

Office Address: Room B3, 18/F Bonsun Industrial Building, 364-366 Sha Tsui Road, Tsuen Wan, HongKong
Phone: 852-39745593 Fax: 852-35440462 info@eastlike.com www.eastlike.com

Installation Accessories

Junction Box

1-6 without the line

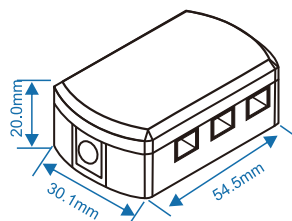

Model	CJB-1IN60-2P
Material	PC
Contol	No Switch
1 Input	(V) DC12V/DC24V
6 Output	(V) DC12V/DC24V

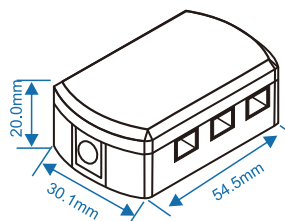

Model	CJB-1IN1SW50-2P
Material	PC
Contol	1 Switch
1 Input	(V) DC12V/DC24V
5 Output	(V) DC12V/DC24V

1-10 with the line

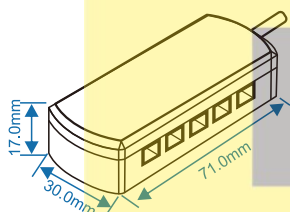

Model	CJB-1IN10-2P
Material	PC
Standard Size (mm)	71*30X17
1 Input	(V) DC12V/DC24V
10 Output	(V) DC12V/DC24V

1-12 with the line

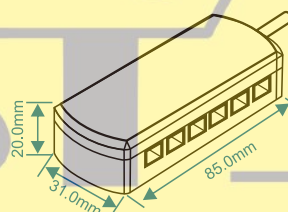

Model	CJB-1W10-2P-L
Material	PC
Standard Size (mm)	85*31*20
1 Input	(V) DC12V/DC24V
12 Output	(V) DC12V/DC24V

1-6 with the line

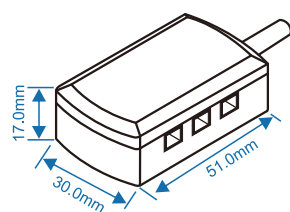

Model	CJB-1IN60-2P-SL
Material	PC
Standard Size (mm)	51*30X17
1 Input	(V) DC12V/DC24V
6 Output	(V) DC12V/DC24V

1-6 with the line

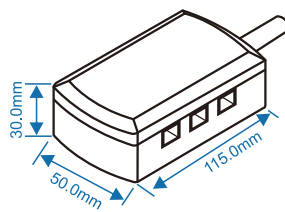

Model	CJB-1N60-2P-DC
Material	PC
Standard Size (mm)	115*50*30
1 Input	(V) DC12V/DC24V
6 Output	(V) DC12V/DC24V

1-4 with the line

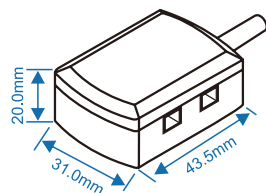

Model	CJB-CJB-1N40-2P-L
Material	PC
Standard Size (mm)	43.5*31*20
1 Input	(V) DC12V/DC24V
6 Output	(V) DC12V/DC24V

1-4 with the line

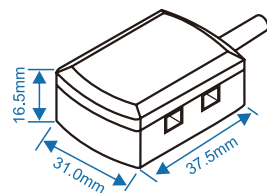

Model	CJB-1INN40-2P-SL
Material	PC
Standard Size (mm)	37.5*31*16.5
1 Input	(V) DC12V/DC24V
4 Output	(V) DC12V/DC24V

Installation Buckle & Clamp



AB-0809



AB-1012



AB-1506



AB-1616



AB-1715



AB-1807



AB-1919C



AB-2310C



AB-1707



AB-2016C



PB-1616

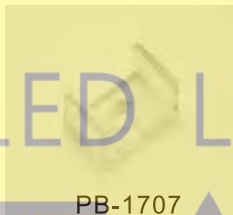

PB-1707

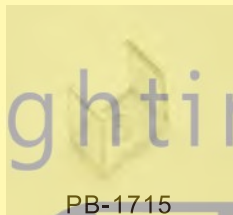

PB-1715

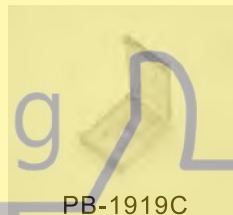

PB-1919C

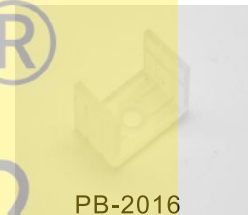

PB-2016

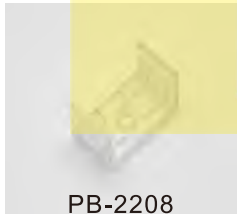

PB-2208

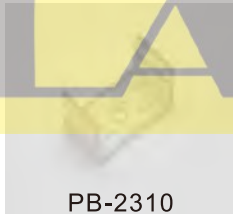

PB-2310

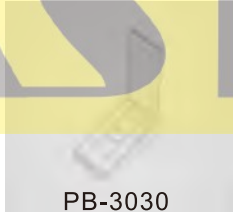

PB-3030

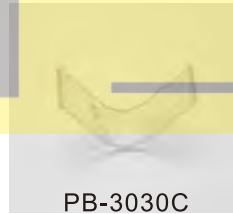

PB-3030C



AB-90°



AB-180°



PB-1516-90°



PB-1516-180°



PB-1616-90°



PB-1616-180°



PB-1707-90°



PB-1707-180°



PB-1715-90°



PB-1715-180°



Spring-Clip01

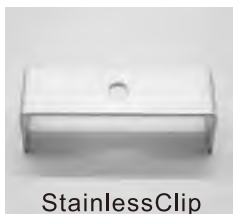

StainlessClip

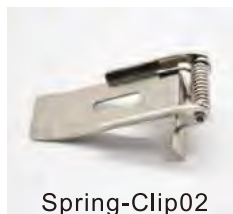

Spring-Clip02



SteelWire



Spring-Clip04



Spring-Clip05

LED Lighting®
EAST



LED Lighting Panel and Downlight

面板燈筒燈系列



東權LED照明公司
EASTLIKE LED Co., Ltd

Office Address: Room B3, 18/F Bonsun Industrial Building, 364-366 Sha Tsui Road, Tsuen Wan, HongKong
Phone: 852-39745593 Fax: 852-35440462 info@eastlike.com www.eastlike.com

Panel Light

Series Type: PN-T

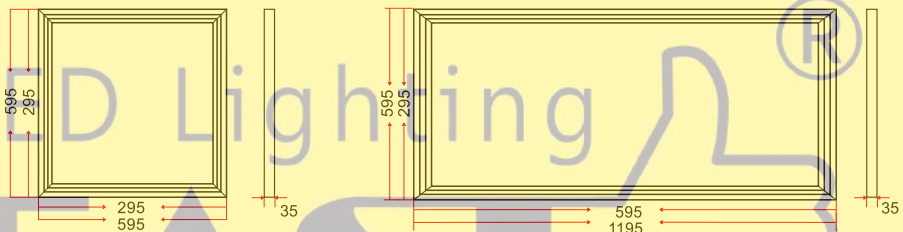

Unit : mm

Features 產品特點>>

- ★ Material: Aluminum 6063+PC
- ★ High color rendering, durable, large light emitting area
- ★ Uniform light emission without flicker
- ★ LED surface mounted front light
- ★ Suitable for living room/bedroom/study/porch/commercial lighting
- ★ 材質: 鋁6063+PC
- ★ 高顯色性, 經久耐用, 發光面積大
- ★ 發光均勻, 無頻閃
- ★ LED明裝正面發光
- ★ 適用客廳/臥室/書房/玄關/商業照明

Specification 產品規格>>

Model 型號	Voltage 電壓 (V)	Power 功率 (W)	Lumen Output 輸出流明 (Lm/W)	Color Rendering 顯色度 (CRI)	Colour Temp 色溫 (K)	Life Time 壽命 (H)	Beam Angle 光束角 (°)	Working temperature 工作溫度 (°C)	Size 尺寸 (mm)
PL-PN-3030-T108A	100~240	9	100	>80	3000/4000/6500	30,000	180	-20~45	295*295
PL-PN-6060-T108A	100~240	36	100	>80	3000/4000/6500	30,000	180	-20~45	595*595
PL-PN-3060-T108A	100~240	18	100	>80	3000/4000/6500	30,000	180	-20~45	295*595
PL-PN-60120-T108A	100~240	72	100	>80	3000/4000/6500	30,000	180	-20~45	595*1195

Light efficiency (lm/W), Power (W), Color Rendering Index (CRI), Size Can be customized according to customer needs
 Our Standard Power factor (PF) > 0.9 and Total harmonic index THD < 15%, According to customer requirements can produce a lower THD < 10%
 This type of certification is issued by a government-approved laboratory for Safety certification, Fire testing, Restriction of Hazardous Substances (RoHS), Photobiological safety of lamps and lamp systems. (an Exemption Group) and other test certifications to ensure product quality

光效 (lm/W)、功率 (W)、顯色指數 (CRI)、尺寸, 可根據客戶需求定制
 此型號標準之功率因素 (PF) > 0.9, 總諧波指數 THD < 15%, 可按客戶需要生產低總諧波指數 < 10%
 此型號認證由可實驗室發出之安全認證消防測試, 環保物料 (RoHS), 光生物安全為 Exemption Group 及其它測試, 保證客戶使用更安心滿意



東攏 LED 照明公司
EASTLIKE LED Co., Ltd

Office Address: Room B3, 18/F Bonsun Industrial Building, 364-366 Sha Tsui Road, Tsuen Wan, HongKong
 Phone: 852-39745593 Fax: 852-35440462 info@eastlike.com www.eastlike.com

Panel Light

Series Type:PN-F



LED Lighting



Unit : mm

Features 產品特點>>

- ★ Material: Aluminum 6063+PC high transparency mask, soft light
- ★ High color rendering, durable, large light emitting area
- ★ Uniform light emission without flicker
- ★ LED surface mounted front light
- ★ Suitable for living room/bedroom/study/porch/commercial lighting
- ★ 材質: 鋁6063+PC高透面罩, 光線柔和
- ★ 高顯色性, 經久耐用, 發光面積大
- ★ 發光均勻, 無頻閃
- ★ LED明裝正面發光
- ★ 適用客廳/臥室/書房/玄關/商業照明

Specification 產品規格>>

Model 型號	Voltage 電壓	Power 功率	Lumen Output 輸出流明	Color Rendering 顯色度	Colour Temp 色溫	Life Time 壽命	Beam Angle 光束角	Working temperature 工作溫度	Size 尺寸
	(V)	(W)	(Lm/W)	(CRI)	(K)	(H)	(°)	(°C)	(mm)
PL-PN-30120-F108A	100-240	10	100	>80	3000/4000/6500	30,000	180	-20~45	295*1195

Light efficiency (lm/W), Power (W), Color Rendering Index (CRI), Size Can be customized according to customer needs

Our Standard Power factor (PF) > 0.9 and Total harmonic index THD < 15%, According to customer requirements can produce a lower THD < 10%

This type of certification is issued by a government-approved laboratory for Safety certification, Fire testing, Restriction of Hazardous Substances (RoHS), Photobiological safety of lamps and lamp systems. (an Exemption Group) and other test certifications to ensure product quality

光效 (lm/W)、功率 (W)、顯色指數 (CRI)、尺寸, 可根據客戶需求定制

此型號標準之功率因素 (PF) > 0.9, 總諧波指數 THD < 15%, 可按客戶需要生產低總諧波指數 < 10%

此型號認證由可實驗室發出之安全認證消防測試, 環保物料 (RoHS), 光生物安全為 Exemption Group 及其它測試, 保證客戶使用更安心滿意



東樞 LED 照明公司
EASTLIKE LED Co., Ltd

Office Address: Room B3, 18/F Bonsun Industrial Building, 364-366 Sha Tsui Road, Tsuen Wan, HongKong
Phone: 852-39745593 Fax: 852-35440462 info@eastlike.com www.eastlike.com

Panel Light

Series Type: PN-C



LED Lighting

EAST

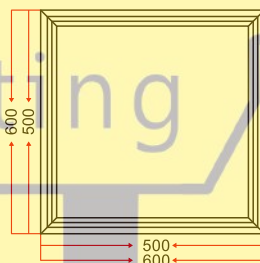

Unit : mm

Features 產品特點>>

- ★ Material: Aluminum 6063+PS high transparency mask, soft light
- ★ High color rendering, durable, large light emitting area
- ★ Uniform light emission without flicker
- ★ LED surface mounted side light
- ★ Suitable for living room/bedroom/study/porch/commercial lighting
- ★ 材質: 鋁6063+PS高透面罩, 光線柔和
- ★ 高顯色性, 經久耐用, 發光面積大
- ★ 發光均勻, 無頻閃
- ★ LED明裝側面發光
- ★ 適用客廳/臥室/書房/玄關/商業照明

Specification 產品規格>>

Model 型號	Voltage 電壓 (V)	Power 功率 (W)	Lumen Output 輸出流明 (Lm/W)	Color Rendering 顯色度 (CRI)	Colour Temp 色溫 (K)	Life Time 壽命 (H)	Beam Angle 光束角 (°)	Working temperature 工作溫度 (°C)	Size 尺寸 (mm)
PL-PN-30120-C108A	100~240	40	100	>80	3000/4000/6000	30,000	180	-20~45	300*1200*38
PL-PN-5050-C108A	100~240	48	100	>80	3000/4000/6000	30,000	180	-20~45	500*500*38
PL-PN-6060-C108A	100~240	48	100	>80	3000/4000/6000	30,000	180	-20~45	600*600*38

Light efficiency (lm/W), Power (W), Color Rendering Index (CRI), Size Can be customized according to customer needs

Our Standard Power factor (PF) > 0.9 and Total harmonic index THD < 15%, According to customer requirements can produce a lower THD < 10%

This type of certification is issued by a government-approved laboratory for Safety certification, Fire testing, Restriction of Hazardous Substances (RoHS), Photobiological safety of lamps and lamp systems. (an Exemption Group) and other test certifications to ensure product quality

光效 (lm/W)、功率 (W)、顯色指數 (CRI)、長度, 可根據客戶需求定制

此型號標準之功率因素 (PF) > 0.9, 總諧波指數 THD < 15%, 可按客戶需要生產低總諧波指數 < 10%

此型號認證由可實驗室發出之安全認證消防測試, 環保物料 (RoHS), 光生物安全為 Exemption Group 及其它測試, 保證客戶使用更安心滿意



東樞 LED 照明公司
EASTLIKE LED Co., Ltd

Office Address: Room B3, 18/F Bonsun Industrial Building, 364-366 Sha Tsui Road, Tsuen Wan, HongKong
Phone: 852-39745593 Fax: 852-35440462 info@eastlike.com www.eastlike.com

Panel Light

Series Type:PN-Z



LED Lighting

EAST

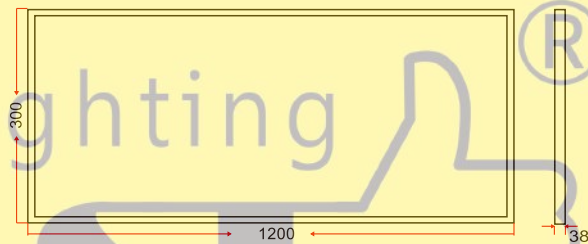

Unit : mm

Features 產品特點>>

- ★ Material: Aluminum 6063+PS high transparency mask, soft light
- ★ High color rendering, durable, large light emitting area
- ★ Uniform light emission without flicker
- ★ LED surface mounted front light
- ★ Suitable for living room/bedroom/study/porch/commercial lighting
- ★ 材質: 鋁6063+PS高透面罩, 光線柔和
- ★ 高顯色性, 經久耐用, 發光面積大
- ★ 發光均勻, 無頻閃
- ★ LED明裝正面發光
- ★ 適用客廳/臥室/書房/玄關/商業照明

Specification 產品規格>>

Model 型號	Voltage 電壓	Power 功率	Lumen Output 輸出流明	Color Rendering 顯色度	Colour Temp 色溫	Life Time 壽命	Beam Angle 光束角	Working temperature 工作溫度	Size 尺寸
	(V)	(W)	(Lm/W)	(CRI)	(K)	(H)	(°)	(°C)	(mm)
PL-PN-30120-Z108A	100~240	40	100	>80	3000/4000/6000	30,000	180	-20~45	300*1200*38
PL-PN-30120-Z108A	100~240	54	100	>80	3000/4000/6000	30,000	180	-20~45	300*1200*38

Light efficiency (lm/W), Power (W), Color Rendering Index (CRI), Size Can be customized according to customer needs

Our Standard Power factor (PF) > 0.9 and Total harmonic index THD < 15%, According to customer requirements can produce a lower THD < 10%

This type of certification is issued by a government-approved laboratory for Safety certification, Fire testing, Restriction of Hazardous Substances (RoHS), Photobiological safety of lamps and lamp systems. (an Exemption Group) and other test certifications to ensure product quality

光效 (lm/W)、功率 (W)、顯色指數 (CRI)、尺寸, 可根據客戶需求定制

此型號標準之功率因素 (PF) > 0.9, 總諧波指數 THD < 15%, 可按客戶需要生產低總諧波指數 < 10%

此型號認證由可實驗室發出之安全認證消防測試, 環保物料 (RoHS), 光生物安全為 Exemption Group 及其它測試, 保證客戶使用更安心滿意



東樞 LED 照明公司
EASTLIKE LED Co., Ltd

Office Address: Room B3, 18/F Bonsun Industrial Building, 364-366 Sha Tsui Road, Tsuen Wan, HongKong
Phone: 852-39745593 Fax: 852-35440462 info@eastlike.com www.eastlike.com

Panel Light

Series Type: PN-JS

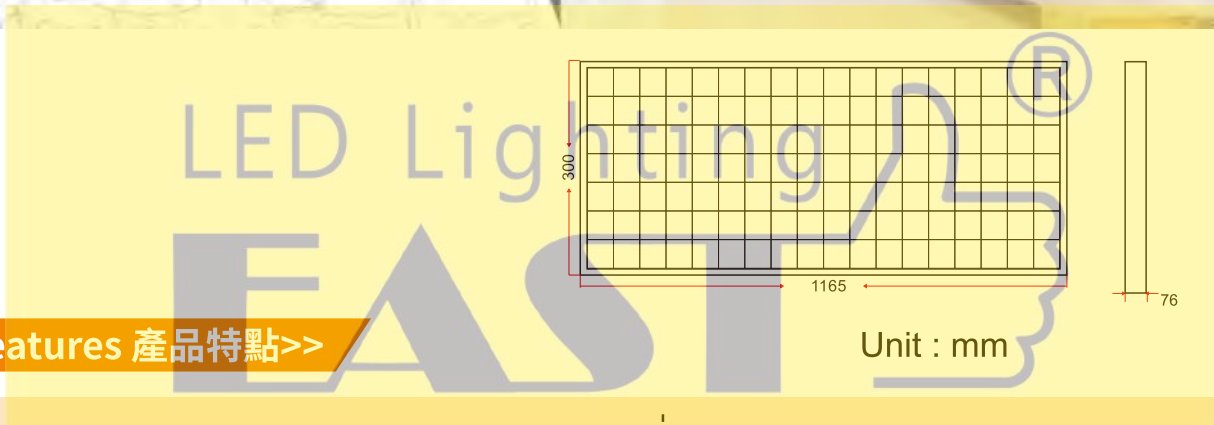

Features 產品特點>>

- ★ Material: Aluminum 6063+PC
- ★ High color rendering, durable, large light emitting area
- ★ Uniform light emission without flicker
- ★ LED surface mounted directional light
- ★ Professional Classroom Blackboard Lamp

- ★ 材質: 鋁6063+PC
- ★ 高顯色性, 經久耐用, 發光面積大
- ★ 發光均勻, 無頻閃
- ★ LED明裝定向發光
- ★ 專業級教室黑板燈

Specification 產品規格>>

Model 型號	Voltage 電壓	Power 功率	Lumen Output 輸出流明	Color Rendering 顯色度	Colour Temp 色溫	Life Time 壽命	Beam Angle 光束角	Working temperature 工作溫度	Size 尺寸
	(V)	(W)	(Lm/W)	(CRI)	(K)	(H)	(°)	(°C)	(mm)
PL-PN-30120-JS108A	100~240	40	100	>80	5000	30,000	180	-20~45	1165*300*76

Light efficiency (lm/W), Power (W), Color Rendering Index (CRI), Size Can be customized according to customer needs
 Our Standard Power factor (PF) > 0.9 and Total harmonic index THD < 15%, According to customer requirements can produce a lower THD < 10%
 This type of certification is issued by a government-approved laboratory for Safety certification, Fire testing, Restriction of Hazardous Substances (RoHS), Photobiological safety of lamps and lamp systems. (an Exemption Group) and other test certifications to ensure product quality

光效 (lm/W)、功率 (W)、顯色指數 (CRI)、長度, 可根據客戶需求定制
 此型號標準之功率因素 (PF) > 0.9, 總諧波指數 THD < 15%, 可按客戶需要生產低總諧波指數 < 10%
 此型號認證由可實驗室發出之安全認證消防測試, 環保物料 (RoHS), 光生物安全為 Exemption Group 及其它測試, 保證客戶使用更安心滿意



東樞 LED 照明公司
EASTLIKE LED Co., Ltd

Office Address: Room B3, 18/F Bonsun Industrial Building, 364-366 Sha Tsui Road, Tsuen Wan, HongKong
 Phone: 852-39745593 Fax: 852-35440462 info@eastlike.com www.eastlike.com

Anti Glare Panel Light

Series Type:PN-A

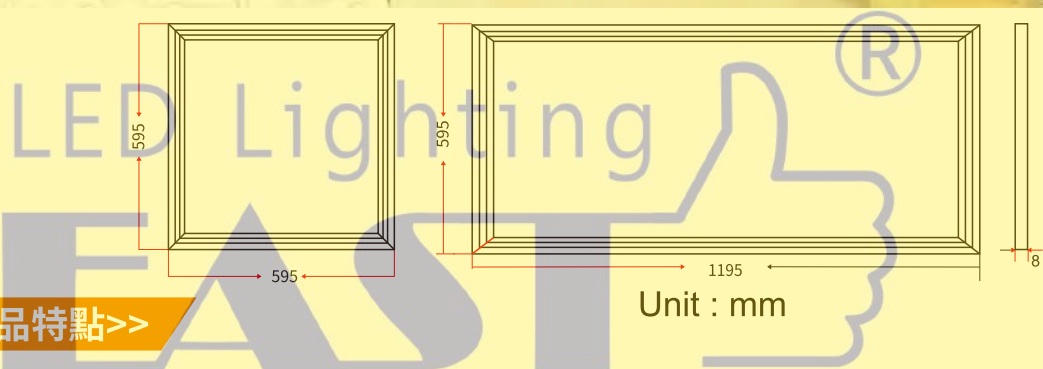

Features 產品特點>>

- ★ Good sealing performance, dust and insect proof, high color rendering index and bright color
- ★ UGR<19 prism plate, anti-glare, no dark area, uniform light, bright, soft, comfortable and not dazzling
- ★ Good heat dissipation structure design can quickly output heat
- ★ Ultra light and ultra-thin, easy to install, embedded installation or ceiling installation, flexible use of space
- ★ Suitable for living room/bedroom/study/porch/commercial lighting
- ★ 密封性能好, 防塵防蟲, 显色指数高, 色彩鮮艷
- ★ UGR<19棱鏡板, 防眩光, 無暗區, 光線均勻, 明亮柔和, 舒適不刺眼
- ★ 良好的散熱結構設計能快速輸出熱量
- ★ 超輕超薄, 安裝方便, 嵌入式安裝或吸頂安裝, 靈活利用空間
- ★ 適用客廳/臥室/書房/玄關/商業照明

Specification 產品規格>>

Model 型號	Voltage 電壓 (V)	Power 功率 (W)	Lumen Output 輸出流明 (Lm/W)	Color Rendering 顯色度 (CRI)	Colour Temp 色溫 (K)	Life Time 壽命 (H)	Beam Angle 光束角 (°)	Prism UGR 棱鏡板	Working temperature 工作溫度 (°C)	Size 尺寸 (mm)
PL-PN-6060-A108A	220-240	36	100	>80	3000/4000/6500	30,000	110	<19 anti-glare	-20~45	575*575
PL-PN-60120-A108A	220-240	54	100	>80	3000/4000/65000	30,000	110	<19 anti-glare	-20~45	575*1175

Light efficiency (lm/W), Power (W), Color Rendering Index (CRI), Size Can be customized according to customer needs

Our Standard Power factor (PF) > 0.9 and Total harmonic index THD < 15%. According to customer requirements can produce a lower THD < 10%

This type of certification is issued by a government-approved laboratory for Safety certification, Fire testing, Restriction of Hazardous Substances (RoHS), Photobiological safety of lamps and lamp systems. (an Exemption Group) and other test certifications to ensure product quality

光效 (lm/W)、功率 (W)、顯色指數 (CRI)、尺寸, 可根據客戶需求定制

此型號標準之功率因素 (PF) > 0.9, 總諧波指數 THD < 15%, 可按客戶需要生產低總諧波指數 < 10%

此型號認證由可實驗室發出之安全認證消防測試, 環保物料 (RoHS), 光生物安全為 Exemption Group 及其它測試, 保證客戶使用更安心滿意



東樞 LED 照明公司
EASTLIKE LED Co., Ltd

Office Address: Room B3, 18/F Bonsun Industrial Building, 364-366 Sha Tsui Road, Tsuen Wan, HongKong
Phone: 852-39745593 Fax: 852-35440462 info@eastlike.com www.eastlike.com

Circular Light

Series Type: ILR-A

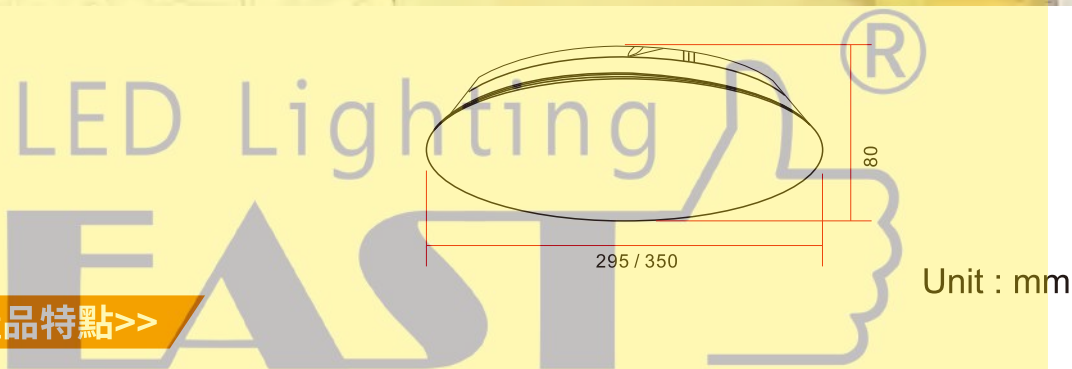

Unit : mm

Features 產品特點>>

- ★ Material: Aluminium+PC Cover
- ★ Uniform light emission
- ★ High luminous output & Low power consumption
- ★ SPM Design – power circuit protection to cut off individual LEDs when mal-functioned
- ★ Easy and firm installation

- ★ 材質：鋁+PC蓋
- ★ 發光均勻
- ★ 高發光輸出和低功耗
- ★ SPM設計-電源電路保護功能可在故障時切斷單個LED
- ★ 輕鬆而牢固的安裝

Specification 產品規格>>

Model 型號	Voltage 電壓 (V)	Power 功率 (W)	Lumen Output 輸出流明 (Lm/W)	Color Rendering 顯色度 (CRI)	Colour Temp 色溫 (K)	Life Time 壽命 (H)	Beam Angle 光束角 (°)	Working temperature 工作溫度 (°C)	Size 尺寸 (mm)
ILR-A16-H108B	85-265	16	100	>80	2700~6500	30,000	180	-20~45	295*80
ILR-A18-N108B	85-265	18	100	>80	2700~6500	30,000	180	-20~45	350*80

Light efficiency (lm/W), Power (W), Color Rendering Index (CRI), Size Can be customized according to customer needs

Our Standard Power factor (PF) > 0.9 and Total harmonic index THD < 15%, According to customer requirements can produce a lower THD < 10%

This type of certification is issued by a government-approved laboratory for Safety certification, Fire testing, Restriction of Hazardous Substances (RoHS), Photobiological safety of lamps and lamp systems. (an Exemption Group) and other test certifications to ensure product quality

光效 (lm/W)、功率 (W)、顯色指數 (CRI)、長度, 可根據客戶需求定制

此型號標準之功率因素 (PF) > 0.9, 總諧波指數 THD < 15%, 可按客戶需要生產低總諧波指數 < 10%

此型號認證由可實驗室發出之安全認證消防測試, 環保物料 (RoHS), 光生物安全為 Exemption Group 及其它測試, 保證客戶使用更安心滿意



東樞 LED 照明公司
EASTLIKE LED Co., Ltd

Office Address: Room B3, 18/F Bonsun Industrial Building, 364-366 Sha Tsui Road, Tsuen Wan, HongKong
Phone: 852-39745593 Fax: 852-35440462 info@eastlike.com www.eastlike.com

Circular Light

Series Type:ILR-T-H



Features 產品特點>>

- ★ Material: Aluminium+PC Cover
 - ★ Uniform light emission
 - ★ High luminous output & Low power consumption
 - ★ SPM Design – power circuit protection to cut off individual LEDs when mal-functioned
 - ★ Easy and firm installation
- ★ 材質: 鋁+ PC蓋
 - ★ 發光均勻
 - ★ 高發光輸出和低功耗
 - ★ SPM設計-電源電路保護功能可在故障時切斷單個LED
 - ★ 輕鬆而牢固的安裝

Specification 產品規格>>

Model 型號	Voltage 電壓	Power 功率	Lumen Output 輸出流明	Color Rendering 顯色度	Colour Temp 色溫	Life Time 壽命	Beam Angle 光束角	Working temperature 工作溫度	Size 尺寸
	(V)	(W)	(Lm/W)	(CRI)	(K)	(H)	(°)	(°C)	(mm)
ILR-T08-H108	85-265	8	100	>80	2700~6500	30,000	180	-20~45	300*39

Light efficiency (lm/W), Power (W), Color Rendering Index (CRI), Size Can be customized according to customer needs

Our Standard Power factor (PF) > 0.9 and Total harmonic index THD < 15%, According to customer requirements can produce a lower THD < 10%

This type of certification is issued by a government-approved laboratory for Safety certification, Fire testing, Restriction of Hazardous Substances (RoHS), Photobiological safety of lamps and lamp systems. (an Exemption Group) and other test certifications to ensure product quality

光效 (lm/W)、功率 (W)、顯色指數 (CRI)、尺寸, 可根據客戶需求定制

此型號標準之功率因素 (PF) > 0.9, 總諧波指數 THD < 15%, 可按客戶需要生產低總諧波指數 < 10%

此型號認證由可實驗室發出之安全認證消防測試, 環保物料 (RoHS), 光生物安全為 Exemption Group 及其它測試, 保證客戶使用更安心滿意



東樞 LED 照明公司
EASTLIKE LED Co., Ltd

Office Address: Room B3, 18/F Bonsun Industrial Building, 364-366 Sha Tsui Road, Tsuen Wan, HongKong
Phone: 852-39745593 Fax: 852-35440462 info@eastlike.com www.eastlike.com

Downlight

Series Type: DL-T

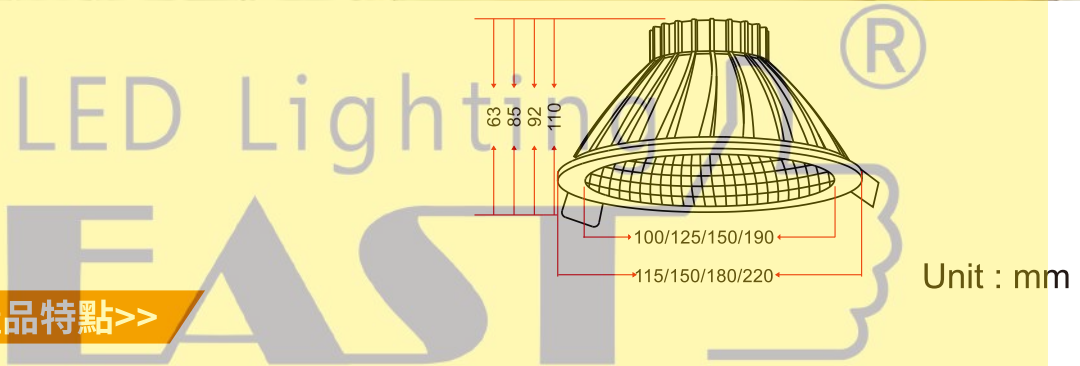

Features 產品特點>>

- ★ Material: Aluminum 6063
- ★ Energy saving: more than 70% energy saving than traditional downlight
- ★ Uniform light emission without flicker
- ★ Lightweight and easy to install
- ★ White external frame can be integrated into any environment
- ★ Designed for commercial and residential use in recessed spaces

- ★ 材質：鋁6063
- ★ 節能：比傳統筒燈節能70%以上
- ★ 發光均勻，無頻閃
- ★ 質量輕，方便安裝
- ★ 白色外部框架可融入任何環境
- ★ 專為商業和住宅嵌入式使用而設計

Specification 產品規格>>

Model 型號	Voltage 電壓	Power 功率	Lumen Output 輸出流明	Color Rendering 顯色度	Colour Temp 色溫	Life Time 壽命	Beam Angle 光束角	Working temperature 工作溫度	Size 尺寸
	(V)	(W)	(Lm/W)	(CRI)	(K)	(H)	(°)	(°C)	(mm)
DL-0405-T108E	85-265	5	100	>80	2700~6500	30,000	90	-20~45	115*63
DL-0507-T108E	85-265	7	100	>80	2700~6500	30,000	90	-20~45	150*85
DL-0608-T108E	85-265	8	100	>80	2700~6500	30,000	90	-20~45	180*92
DL-0810-T108E	85-265	9	100	>80	2700~6500	30,000	90	-20~45	220*110

Light efficiency (lm/W), Power (W), Color Rendering Index (CRI), Size Can be customized according to customer needs

Our Standard Power factor (PF) > 0.9 and Total harmonic index THD < 15%, According to customer requirements can produce a lower THD < 10%

This type of certification is issued by a government-approved laboratory for Safety certification, Fire testing, Restriction of Hazardous Substances (RoHS), Photobiological safety of lamps and lamp systems. (an Exemption Group) and other test certifications to ensure product quality

光效 (lm/W)、功率 (W)、顯色指數 (CRI)、長度，可根據客戶需求定制

此型號標準之功率因素 (PF) > 0.9，總諧波指數 THD < 15%，可按客戶需要生產低總諧波指數 < 10%

此型號認證由可實驗室發出之安全認證消防測試，環保物料 (RoHS)，光生物安全為 Exemption Group 及其它測試，保證客戶使用更安心滿意



東攏 LED 照明公司
EASTLIKE LED Co., Ltd

Office Address: Room B3, 18/F Bonsun Industrial Building, 364-366 Sha Tsui Road, Tsuen Wan, HongKong
Phone: 852-39745593 Fax: 852-35440462 info@eastlike.com www.eastlike.com

Downlight

Series Type: DL-R

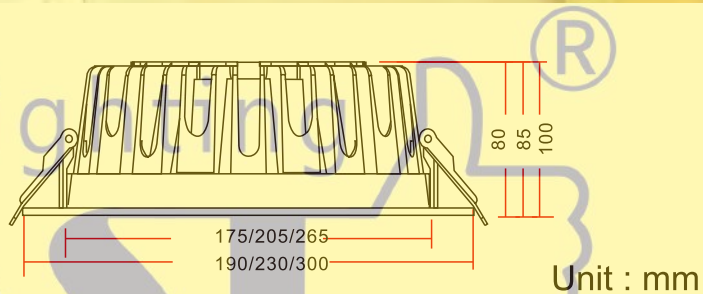

Unit : mm

Features 產品特點>>

- ★ Material: Aluminum 6063
- ★ Energy saving: more than 70% energy saving than traditional downlight
- ★ Uniform light emission without flicker
- ★ Lightweight and easy to install
- ★ White external frame can be integrated into any environment
- ★ Designed for commercial and residential use in recessed spaces

- ★ 材質：鋁6063
- ★ 節能：比傳統筒燈節能70%以上
- ★ 發光均勻，無頻閃
- ★ 質量輕，方便安裝
- ★ 白色外部框架可融入任何環境
- ★ 專為商業和住宅嵌入式使用而設計

Specification 產品規格>>

Model 型號	Voltage 電壓	Power 功率	Lumen Output 輸出流明	Color Rendering 顯色度	Colour Temp 色溫	Life Time 壽命	Beam Angle 光束角	Working temperature 工作溫度	Size 尺寸
	(V)	(W)	(Lm/W)	(CRI)	(K)	(H)	(°)	(°C)	(mm)
DL-0612-R108B	85-265	12	100	>80	2700~6500	30,000	90	-20~45	190*80
DL-0820-R108B	85-265	20	100	>80	2700~6500	30,000	90	-20~45	230*85
DL-1035-R108B	85-265	35	100	>80	2700~6500	30,000	90	-20~45	300*100

Light efficiency (lm/W), Power (W), Color Rendering Index (CRI), Size Can be customized according to customer needs
 Our Standard Power factor (PF) > 0.9 and Total harmonic index THD < 15%, According to customer requirements can produce a lower THD < 10%
 This type of certification is issued by a government-approved laboratory for Safety certification, Fire testing, Restriction of Hazardous Substances (RoHS), Photobiological safety of lamps and lamp systems. (an Exemption Group) and other test certifications to ensure product quality

光效 (lm/W)、功率 (W)、顯色指數 (CRI)、尺寸，可根據客戶需求定制
 此型號標準之功率因素 (PF) > 0.9，總諧波指數 THD < 15%，可按客戶需要生產低總諧波指數 < 10%
 此型號認證由可實驗室發出之安全認證消防測試，環保物料 (RoHS)，光生物安全為 Exemption Group 及其它測試，保證客戶使用更安心滿意



東樞 LED 照明公司
EASTLIKE LED Co., Ltd

Office Address: Room B3, 18/F Bonsun Industrial Building, 364-366 Sha Tsui Road, Tsuen Wan, HongKong
 Phone: 852-39745593 Fax: 852-35440462 info@eastlike.com www.eastlike.com

Downlight

Series Type: DL-UC

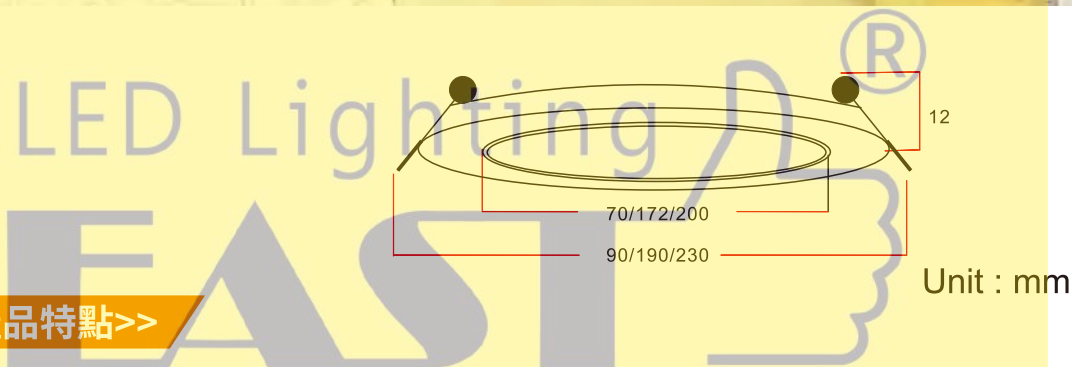

Features 產品特點>>

- ★ Material: Aluminum 6063
- ★ Energy saving: more than 70% energy saving than traditional downlight
- ★ Uniform light emission without flicker
- ★ Low Heat generation
- ★ Lightweight and easy to install
- ★ White external frame can be integrated into any environment
- ★ Designed for commercial and residential use in recessed spaces

- ★ 材質：鋁6063
- ★ 節能：比傳統筒燈節能70%以上
- ★ 發光均勻，無頻閃
- ★ 低熱能釋放
- ★ 質量輕，方便安裝
- ★ 白色外部框架可融入任何環境
- ★ 專為商業和住宅嵌入式使用而設計

Specification 產品規格>>

Model 型號	Voltage 電壓 (V)	Power 功率 (W)	Lumen Output 輸出流明 (Lm/W)	Color Rendering 顯色度 (CRI)	Colour Temp 色溫 (K)	Life Time 壽命 (H)	Beam Angle 光束角 (°)	Working temperature 工作溫度 (°C)	Size 尺寸 (mm)
DL-0303-UC108A	85-265	3	100	>80	2700~6500	30,000	180	-20~45	90*12
DL-0612-UC108A	85-265	12	100	>80	2700~6500	30,000	180	-20~45	190*12
DL-0818-UC108A	85-265	18	100	>80	2700~6500	30,000	180	-20~45	230*12

Light efficiency (lm/W), Power (W), Color Rendering Index (CRI), Size Can be customized according to customer needs

Our Standard Power factor (PF) > 0.9 and Total harmonic index THD < 15%, According to customer requirements can produce a lower THD < 10%

This type of certification is issued by a government-approved laboratory for Safety certification, Fire testing, Restriction of Hazardous Substances (RoHS), Photobiological safety of lamps and lamp systems. (an Exemption Group) and other test certifications to ensure product quality

光效 (lm/W)、功率 (W)、顯色指數 (CRI)、長度，可根據客戶需求定制

此型號標準之功率因素 (PF) > 0.9，總諧波指數 THD < 15%，可按客戶需要生產低總諧波指數 < 10%

此型號認證由可實驗室發出之安全認證消防測試，環保物料 (RoHS)，光生物安全為 Exemption Group 及其它測試，保證客戶使用更安心滿意



東櫛 LED 照明公司
EASTLIKE LED Co., Ltd

Office Address: Room B3, 18/F Bonsun Industrial Building, 364-366 Sha Tsui Road, Tsuen Wan, HongKong
Phone: 852-39745593 Fax: 852-35440462 info@eastlike.com www.eastlike.com

Downlight

Series Type: DL-S

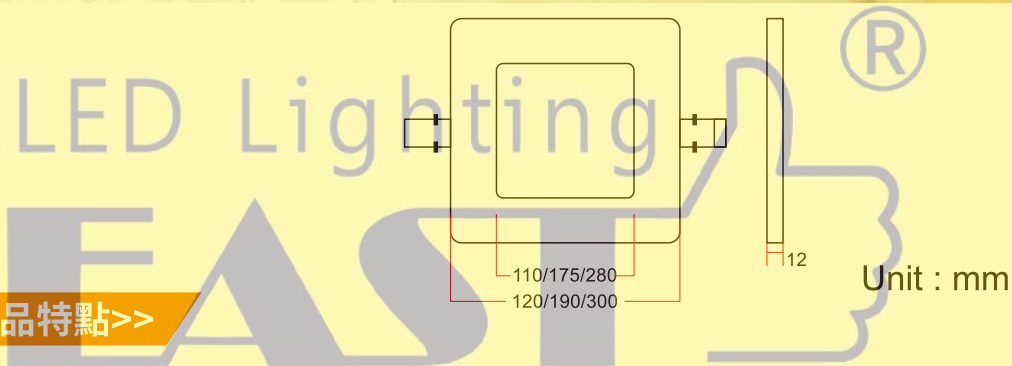

Features 產品特點>>

- ★ Material: Aluminum 6063+PC
- ★ Energy saving: more than 70% energy saving than traditional downlight
- ★ Uniform light emission without flicker
- ★ Low Heat generation
- ★ Lightweight and easy to install
- ★ White external frame can be integrated into any environment
- ★ Designed for commercial and residential use in recessed spaces

- ★ 材質: 鋁6063+PC
- ★ 節能: 比傳統筒燈節能70%以上
- ★ 發光均勻, 無頻閃
- ★ 低熱能釋放
- ★ 質量輕, 方便安裝
- ★ 白色外部框架可融入任何环境
- ★ 專為商業和住宅嵌入式使用而設計

Specification 產品規格>>

Model 型號	Voltage 電壓 (V)	Power 功率 (W)	Lumen Output 輸出流明 (Lm/W)	Color Rendering 顯色度 (CRI)	Colour Temp 色溫 (K)	Life Time 壽命 (H)	Beam Angle 光束角 (°)	Working temperature 工作溫度 (°C)	Size 尺寸 (mm)
DL-0406-MEP-S	85-265	6	100	>80	2700~6500	30,000	180	-20~45	120*12
DL-0715-MEP-S	85-265	15	100	>80	2700~6500	30,000	180	-20~45	190*12
DL-1024-MEP-S	85-265	24	100	>80	2700~6500	30,000	180	-20~45	300*12

Light efficiency (lm/W), Power (W), Color Rendering Index (CRI), Size Can be customized according to customer needs

Our Standard Power factor (PF) > 0.9 and Total harmonic index THD < 15%. According to customer requirements can produce a lower THD < 10%

This type of certification is issued by a government-approved laboratory for Safety certification, Fire testing, Restriction of Hazardous Substances (RoHS), Photobiological safety of lamps and lamp systems. (an Exemption Group) and other test certifications to ensure product quality

光效 (lm/W)、功率 (W)、顯色指數 (CRI)、尺寸, 可根據客戶需求定制

此型號標準之功率因素 (PF) > 0.9, 總諧波指數 THD < 15%, 可按客戶需要生產低總諧波指數 < 10%

此型號認證由可實驗室發出之安全認證消防測試, 環保物料 (RoHS), 光生物安全為 Exemption Group 及其它測試, 保證客戶使用更安心滿意



東樞 LED 照明公司
EASTLIKE LED Co., Ltd

Office Address: Room B3, 18/F Bonsun Industrial Building, 364-366 Sha Tsui Road, Tsuen Wan, HongKong
Phone: 852-39745593 Fax: 852-35440462 info@eastlike.com www.eastlike.com

Track Light

Series Type: TL-Q



LED Lighting

EAST

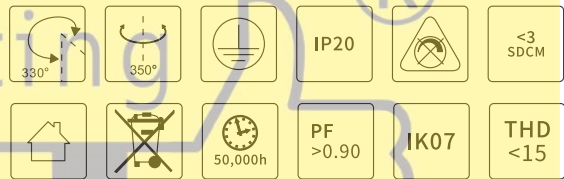

Features 產品特點>>

- ★ Material: high quality aluminum alloy profile + PC reflector with lens
- ★ Dark light Aluminum reflector UGR<19
- ★ Uniform light emission without flicker
- ★ The position can be adjusted in multiple directions as required
- ★ Application: shopping malls, jewelry, brand clothing, high-end clubs, professional windows, counters and other key lighting places
- ★ Certificate: CE RoHS

- ★ 材质: 优质铝合金型材+带透镜的PC反光镜
- ★ 暗光铝反射镜UGR<19
- ★ 发光均匀, 无频闪
- ★ 照射位置可根据需要进行多个方位调整
- ★ 应用场所: 商场、珠宝首饰、品牌服饰、高档会所、专业橱窗、柜台等重点照明场所
- ★ 证书: CE RoHS

Specification 產品規格>>

Model 型號	Voltage 電壓 (V)	Power 功率 (W)	Lumen Output 輸出流明 (Lm/W)	Color Rendering 顯色度 (CRI)	Colour Temp 色溫 (K)	Life Time 壽命 (H)	Beam Angle 光束角 (°)	Working temperature 工作溫度 (°C)	Size 尺寸 (mm)
TL-A20-H108E-Q	100~240	20	100	>80	2700/3000/4000/5000	30,000	15/24/38/60	-20~45	90*155
TL-A25-H108E-Q	100~240	25	100	>80	2700/3000/4000/5000	30,000	15/24/38/60	-20~45	90*155
TL-A30-H108E-Q	100~240	30	100	>80	2700/3000/4000/5000	30,000	15/24/38/60	-20~45	90*155

Light efficiency (lm/W), Power (W), Color Rendering Index (CRI), Size Can be customized according to customer needs

Our Standard Power factor (PF) > 0.9 and Total harmonic index THD < 15%, According to customer requirements can produce a lower THD < 10%

This type of certification is issued by a government-approved laboratory for Safety certification, Fire testing, Restriction of Hazardous Substances (RoHS), Photobiological safety of lamps and lamp systems. (an Exemption Group) and other test certifications to ensure product quality

光效 (lm/W)、功率 (W)、顯色指數 (CRI)、長度, 可根據客戶需求定制

此型號標準之功率因素 (PF) > 0.9, 總諧波指數 THD < 15%, 可按客戶需要生產低總諧波指數 < 10%

此型號認證由可實驗室發出之安全認證消防測試, 環保物料 (RoHS), 光生物安全為 Exemption Group 及其它測試, 保證客戶使用更安心滿意



東樞 LED 照明公司
EASTLIKE LED Co., Ltd

Office Address: Room B3, 18/F Bonsun Industrial Building, 364-366 Sha Tsui Road, Tsuen Wan, HongKong
Phone: 852-39745593 Fax: 852-35440462 info@eastlike.com www.eastlike.com

Track Light

Series Type: TL-F2



LED Lighting

EAST

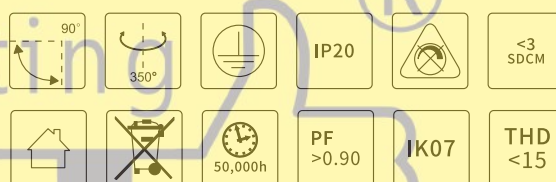

Features 產品特點>>

- | | |
|------------------------------------------------------------------------------------------------------------------------------------------------------------------------------------------------------------------------------------------------------------------------------------------------------------------------------------------------------------------------------------------------------------------------------------------------------------------------------------------------------|------------------------------------------------------------------------------------------------------------------------------------------------------------------------------------------------------------------------|
| <ul style="list-style-type: none"> ★ Material: high quality aluminum alloy profile + PC Lens ★ Uniform light emission without flick ★ High luminous efficiency, energy saving and environmental protection ★ The position can be adjusted in multiple directions as required ★ Application: shopping malls, jewelry, brand clothing, high-end clubs, professional windows, counters and other key lighting places ★ Certificate: CE RoHS | <ul style="list-style-type: none"> ★ 材质: 优质铝合金型材+PC透镜 ★ 發光均勻, 無頻閃 ★ 發光效率高, 節能環保 ★ 照射位置可根據需要進行多個方位調整 ★ 應用場所: 商場、珠寶首飾、品牌服飾、高檔會所、專業櫥窗、櫃檯等重點照明場所 ★ 證書: CE RoHS |
|------------------------------------------------------------------------------------------------------------------------------------------------------------------------------------------------------------------------------------------------------------------------------------------------------------------------------------------------------------------------------------------------------------------------------------------------------------------------------------------------------|------------------------------------------------------------------------------------------------------------------------------------------------------------------------------------------------------------------------|

Specification 產品規格>>

Model 型號	Voltage 電壓	Power 功率	Lumen Output 輸出流明	Color Rendering 顯色度	Colour Temp 色溫	Life Time 壽命	Beam Angle 光束角	Working temperature 工作溫度	Size 尺寸
	(V)	(W)	(Lm/W)	(CRI)	(K)	(H)	(°)	(°C)	(mm)
TL-A15-H108E-F2	100~240	15	100	>80	2700/3000/4000/5000	30,000	15/24/38	-20~45	80*150
TL-A20-H108E-F2	100~240	20	100	>80	2700/3000/4000/5000	30,000	15/24/38	-20~45	80*150
TL-A30-H108E-F2	100~240	30	100	>80	2700/3000/4000/5000	30,000	15/24/38	-20~45	90*190

Light efficiency (lm/W), Power (W), Color Rendering Index (CRI), Size Can be customized according to customer needs

Our Standard Power factor (PF) > 0.9 and Total harmonic index THD < 15%. According to customer requirements can produce a lower THD < 10%

This type of certification is issued by a government-approved laboratory for Safety certification, Fire testing, Restriction of Hazardous Substances (RoHS), Photobiological safety of lamps and lamp systems. (an Exemption Group) and other test certifications to ensure product quality

光效 (lm/W)、功率 (W)、顯色指數 (CRI)、尺寸, 可根據客戶需求定制

此型號標準之功率因素 (PF) > 0.9, 總諧波指數 THD < 15%, 可按客戶需要生產低總諧波指數 < 10%

此型號認證由可實驗室發出之安全認證消防測試, 環保物料 (RoHS), 光生物安全為 Exemption Group 及其它測試, 保證客戶使用更安心滿意



東樞 LED 照明公司
EASTLIKE LED Co., Ltd

Office Address: Room B3, 18/F Bonsun Industrial Building, 364-366 Sha Tsui Road, Tsuen Wan, HongKong
Phone: 852-39745593 Fax: 852-35440462 info@eastlike.com www.eastlike.com

Track Light

Series Type: TL-K

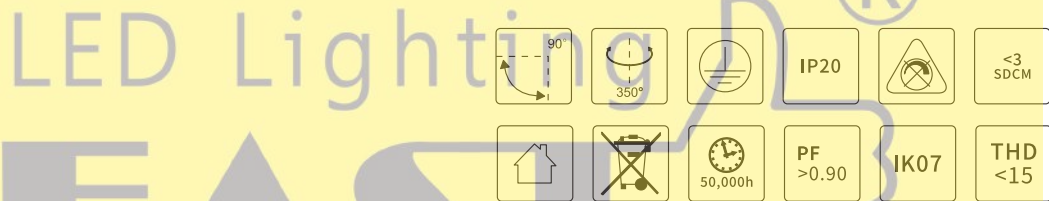

Features 產品特點>>

- | | |
|------------------------------------------------------------------------------------------------------------------------------------------------------------------------------------------------------------------------------------------------------------------------------------------------------------------------------------------------------------------------------------------------------------------------------------------------------------------------------------------|---------------------------------------------------------------------------------------------------------------------------------------------------------------------------------------------------------------------------------|
| <ul style="list-style-type: none"> ★ Material: high quality aluminum alloy profile + PC reflector with lens ★ Dark light Aluminum reflector UGR<19 ★ Uniform light emission without flicker ★ The position can be adjusted in multiple directions as required ★ Application: shopping malls, jewelry, brand clothing, high-end clubs, professional windows, counters and other key lighting places ★ Certificate: CE RoHS | <ul style="list-style-type: none"> ★ 材质: 优质铝合金型材+带透镜的PC反光镜 ★ 暗光铝反射镜UGR<19 ★ 发光均匀, 无频闪 ★ 照射位置可根据需要进行多个方位调整 ★ 应用场所: 商场、珠宝首饰、品牌服饰、高档会所、专业橱窗、柜台等重点照明场所 ★ 证书: CE RoHS |
|------------------------------------------------------------------------------------------------------------------------------------------------------------------------------------------------------------------------------------------------------------------------------------------------------------------------------------------------------------------------------------------------------------------------------------------------------------------------------------------|---------------------------------------------------------------------------------------------------------------------------------------------------------------------------------------------------------------------------------|

Specification 產品規格>>

Model 型號	Voltage 電壓	Power 功率	Lumen Output 輸出流明	Color Rendering 顯色度	Colour Temp 色溫	Life Time 壽命	Beam Angle 光束角	Working temperature 工作溫度	Size 尺寸
	(V)	(W)	(Lm/W)	(CRI)	(K)	(H)	(°)	(°C)	(mm)
TL-A15-H108E-K	100~240	15	100	>80	2700/3000/4000/5000	30,000	15/24/38/60	-20~45	62*140
TL-A20-H108E-K	100~240	20	100	>80	2700/3000/4000/5000	30,000	15/24/38/60	-20~45	90*165
TL-A30-H108E-K	100~240	30	100	>80	2700/3000/4000/5000	30,000	15/24/38/60	-20~45	90*165

Light efficiency (lm/W), Power (W), Color Rendering Index (CRI), Size Can be customized according to customer needs

Our Standard Power factor (PF) > 0.9 and Total harmonic index THD < 15%, According to customer requirements can produce a lower THD < 10%

This type of certification is issued by a government-approved laboratory for Safety certification, Fire testing, Restriction of Hazardous Substances (RoHS), Photobiological safety of lamps and lamp systems. (an Exemption Group) and other test certifications to ensure product quality

光效 (lm/W)、功率 (W)、顯色指數 (CRI)、長度, 可根據客戶需求定制

此型號標準之功率因素 (PF) > 0.9, 總諧波指數 THD < 15%, 可按客戶需要生產低總諧波指數 < 10%

此型號認證由可實驗室發出之安全認證消防測試, 環保物料 (RoHS), 光生物安全為 Exemption Group 及其它測試, 保證客戶使用更安心滿意



東欄 LED 照明公司
EASTLIKE LED Co., Ltd

Office Address: Room B3, 18/F Bonsun Industrial Building, 364-366 Sha Tsui Road, Tsuen Wan, HongKong
Phone: 852-39745593 Fax: 852-35440462 info@eastlike.com www.eastlike.com

LED lighting Industrial Lighting Series

工業照明系列



東樞LED照明公司
EASTLIKE LED Co., Ltd

Office Address: Room B3, 18/F Bonsun Industrial Building, 364-366 Sha Tsui Road, Tsuen Wan, HongKong
Phone: 852-39745593 Fax: 852-35440462 info@eastlike.com www.eastlike.com

LED Floodlight

Series Type:FL-A-C



LED Lighting

EAST

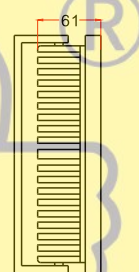
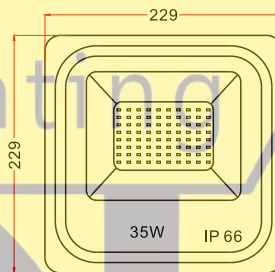

Unit : mm

Features 產品特點>>

- ★ Material: aluminum, PC shell
- ★ Using high performance Philips SMD LED(100lm/W)
- ★ Flexible mounting bracket for easy installation and removal
- ★ Better heat dissipation design to extend product life
- ★ Suitable for indoor and outdoor lighting applications
- ★ Certificate: CE RoHS

- ★ 外殼材料: 鋁, PC外殼
- ★ 採用高性能飛利浦 SMD LED(100lm / W)
- ★ 靈活的安裝支架, 方便安裝和拆卸
- ★ 更好的散熱設計, 延長產品使用壽命
- ★ 適用於室內和室外照明應用
- ★ 證書: CE RoHS

Specification 產品規格>>

Model 型號	Voltage 電壓	Power 功率	Lumen 流明	Power factor 功率因數	Colour Temp 色溫	Life Time 壽命	Beam Angle 光束角	Working temperature 工作溫度	IP rating IP等級	Size 尺寸
	(V)	(W)	(lm)	(PF)	(K)	(H)	(°)	(°C)		(mm)
FL-A35-C108B	85~265	35	3500	>0.9	2700-6500	30,000	120	-20~45	66	229*229*61

LED, power (W), driver can be customized according to customer needs
 Our Standard Color Rendering (CRI) > 70 and Total harmonic index THD < 15%,
 According to customer requirements can produce a lower THD < 10%
 This type of certification is issued by a government-approved laboratory for Safety
 certification, Fire testing, Restriction of Hazardous Substances(RoHS),
 Photobiological safety of lamps and lamp systems.(an Exemption Group) and other
 test certifications to ensure product quality

LED、功率(W)、驅動可根據客戶需求定制
 此型號標準之顯色指數(CRI)>70, 總諧波指數THD<15%, 可按客戶需要生產低總諧波指
 數<10%
 此型號認證由可實驗室發出之安全認證消防測試, 環保物料(RoHS), 光生物安全為
 Exemption Group及其它測試, 保證客戶使用更安心滿意



東權LED照明公司
EASTLIKE LED Co., Ltd

Office Address: Room B3, 18/F Bonsun Industrial Building, 364-366 Sha Tsui Road, Tsuen Wan, HongKong
 Phone: 852-39745593 Fax: 852-35440462 info@eastlike.com www.eastlike.com

LED Floodlight

Series Type:FL-A-H

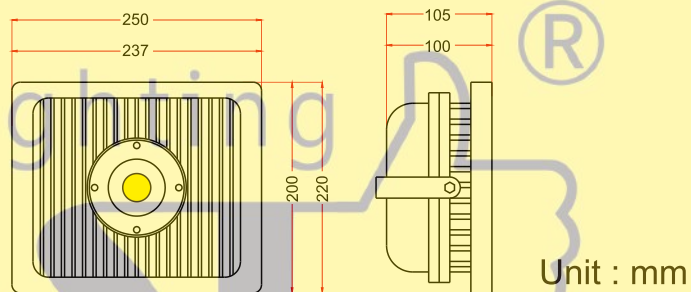

Features 產品特點>>

- ★ Material: aluminum, PC
- ★ Using the famous Bridgelux COB LED(100lm/W)
- ★ Flexible mounting bracket for easy installation and removal
- ★ Better heat dissipation design to extend product life
- ★ Suitable for indoor and outdoor lighting applications
- ★ Certificate: CE RoHS

- ★ 外殼材料: 鋁, PC
- ★ 採用著名的Bridgelux COB LED (100lm / W)
- ★ 靈活的安裝支架, 方便安裝和拆卸
- ★ 更好的散熱設計, 延長產品使用壽命
- ★ 適用於室內和室外照明應用
- ★ 證書: CE RoHS

Specification 產品規格>>

Model 型號	Voltage 電壓	Power 功率	Lumen 流明	Power factor 功率因數	Colour Temp 色溫	Life Time 壽命	Beam Angle 光束角	Working temperature 工作溫度	IP rating IP等級	Size 尺寸
	(V)	(W)	(lm)	(PF)	(K)	(H)	(°)	(°C)		(mm)
FL-A20-H108E	85~265	20	2000	>0.9	2700-6500	30,000	120	-20~45	66	237*200*100
FL-A30-H108E	85~265	30	3000	>0.9	2700-6500	30,000	120	-20~45	66	237*200*100
FL-A50-H108E	85~265	50	5000	>0.9	2700-6500	30,000	120	-20~45	66	250*220*105

LED, power (W), driver can be customized according to customer needs
 Our Standard Color Rendering (CRI) > 70 and Total harmonic index THD < 15%,
 According to customer requirements can produce a lower THD < 10%
 This type of certification is issued by a government-approved laboratory for Safety
 certification, Fire testing, Restriction of Hazardous Substances(RoHS),
 Photobiological safety of lamps and lamp systems.(an Exemption Group) and other
 test certifications to ensure product quality

LED、功率(W)、驅動可根據客戶需求定制
 此型號標準之显色指数(CRI)>70,總諧波指數THD<15%,可按客戶需要生產低總諧波指
 數<10%
 此型號認證由可實驗室發出之安全認證消防測試,環保物料(RoHS),光生物安全為
 Exemption Group及其它測試,保證客戶使用更安心滿意



東權LED照明公司
EASTLIKE LED Co., Ltd

Office Address: Room B3, 18/F Bonsun Industrial Building, 364-366 Sha Tsui Road, Tsuen Wan, HongKong
 Phone: 852-39745593 Fax: 852-35440462 info@eastlike.com www.eastlike.com

LED Floodlight

Series Type:FL-A100-H

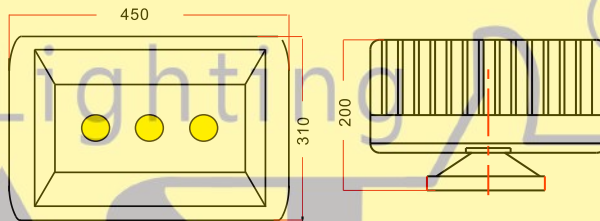

Unit : mm

Features 產品特點>>

- ★ Material: aluminum, Clear tempered Glass
- ★ Using the famous Bridgelux COB LED
- ★ Flexible mounting bracket for easy installation and removal
- ★ Better heat dissipation design to extend product life
- ★ Suitable for indoor and outdoor lighting applications
- ★ Certificate: CE RoHS

- ★ 外殼材料: 鋁, 透明鋼化玻璃
- ★ 採用著名的Bridgelux COB LED
- ★ 靈活的安裝支架, 方便安裝和拆卸
- ★ 更好的散熱設計, 延長產品使用壽命
- ★ 適用於室內和室外照明應用
- ★ 證書: CE RoHS

Specification 產品規格>>

Model 型號	Voltage 電壓	Power 功率	Lumen 流明	Power factor 功率因數	Colour Temp 色溫	Life Time 壽命	Beam Angle 光束角	Working temperature 工作溫度	IP rating IP等級	Size 尺寸
	(V)	(W)	(lm)	(PF)	(K)	(H)	(°)	(°C)		(mm)
FL-A100-H108E	85~265	100	10000	>0.9	2700~6500	30,000	120	-20~45	66	360*250*135
FL-A150-H108E	85~265	150	15000	>0.9	2700~6500	30,000	120	-20~45	66	450*310*200
FL-A200-H108E	85~265	200	20000	>0.9	2700~6500	30,000	120	-20~45	66	510*320*200
FL-A250-H108E	85~265	250	25000	>0.9	2700~6500	30,000	120	-20~45	66	650*320*200
FL-A300-H108E	85~265	300	30000	>0.9	2700~6500	30,000	120	-20~45	66	740*320*200

LED, power (W), driver can be customized according to customer needs
 Our Standard Color Rendering (CRI) > 70 and Total harmonic index THD < 15%,
 According to customer requirements can produce a lower THD < 10%
 This type of certification is issued by a government-approved laboratory for Safety
 certification, Fire testing, Restriction of Hazardous Substances(RoHS),
 Photobiological safety of lamps and lamp systems.(an Exemption Group) and other
 test certifications to ensure product quality

LED、功率(W)、驅動可根據客戶需求定制
 此型號標準之顯色指數(CRI)>70, 總諧波指數THD<15%, 可按客戶需要生產低總諧波指
 數<10%
 此型號認證由可實驗室發出之安全認證消防測試, 環保物料(RoHS), 光生物安全為
 Exemption Group及其它測試, 保證客戶使用更安心滿意



東權LED照明公司
EASTLIKE LED Co., Ltd

Office Address: Room B3, 18/F Bonsun Industrial Building, 364-366 Sha Tsui Road, Tsuen Wan, HongKong
 Phone: 852-39745593 Fax: 852-35440462 info@eastlike.com www.eastlike.com

LED Floodlight

Series Type:FL-A-FQ

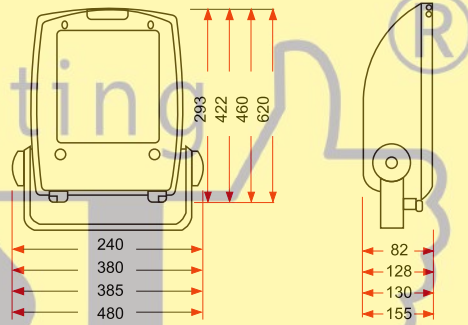

Unit : mm

Features 產品特點>>

- ★ Material: Die-casting aluminum body
- ★ Using the famous Bridgelux COB LED (100lm/W)
- ★ Flexible mounting bracket for easy installation and removal
- ★ Better heat dissipation design to extend product life
- ★ Suitable for indoor and outdoor lighting applications
- ★ Finishes:White/Black/Gray
- ★ Certificate: CE RoHS

- ★ 外殼材料:壓鑄鋁機身
- ★ 採用著名的Bridgelux COB LED (100lm / W)
- ★ 靈活的安裝支架,方便安裝和拆卸
- ★ 更好的散熱設計,延長產品使用壽命
- ★ 適用於室內和室外照明應用
- ★ 表面處理:白色/黑色/灰色
- ★ 證書:CE RoHS

Specification 產品規格>>

Model 型號	Voltage 電壓 (V)	Power 功率 (W)	Lumen 流明 (lm)	Power factor 功率因數 (PF)	Colour Temp 色溫 (K)	Life Time 壽命 (H)	Beam Angle 光束角 (°)	Working temperature 工作溫度 (°C)	IP rating IP等級	Size 尺寸 (mm)
FL-A50-FQ35	85~305	50	5000	>0.9	2700-6500	30,000	120	-45~75	66	293*240*82
FL-A100-FQ310	85~305	100	10000	>0.9	2700-6500	30,000	120	-45~75	66	422*380*128
FL-A150-FQ315	85~305	150	15000	>0.9	2700-6500	30,000	120	-45~75	66	460*385*130
FL-A200-FQ320	85~305	200	20000	>0.9	2700-6500	30,000	120	-45~75	66	620*480*155

LED, power (W), driver can be customized according to customer needs
Our Standard Color Rendering (CRI) > 70 and Total harmonic index THD < 15%,
According to customer requirements can produce a lower THD < 10%
This type of certification is issued by a government-approved laboratory for Safety
certification, Fire testing, Restriction of Hazardous Substances(RoHS),
Photobiological safety of lamps and lamp systems.(an Exemption Group) and other
test certifications to ensure product quality

LED、功率(W)、驅動可根據客戶需求定制
此型號標準之顯色指數(CRI)>70,總諧波指數THD<15%,可按客戶需要生產低總諧波指
數<10%
此型號認證由可實驗室發出之安全認證消防測試,環保物料(RoHS),光生物安全為
Exemption Group及其它測試,保證客戶使用更安心滿意



東權LED照明公司
EASTLIKE LED Co., Ltd

Office Address: Room B3, 18/F Bonsun Industrial Building, 364-366 Sha Tsui Road, Tsuen Wan, HongKong
Phone: 852-39745593 Fax: 852-35440462 info@eastlike.com www.eastlike.com

LED High Bay Light

Series Type: HB-A100-H-UFO

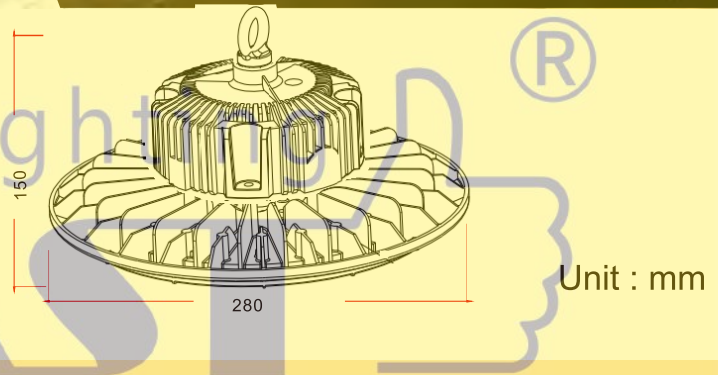
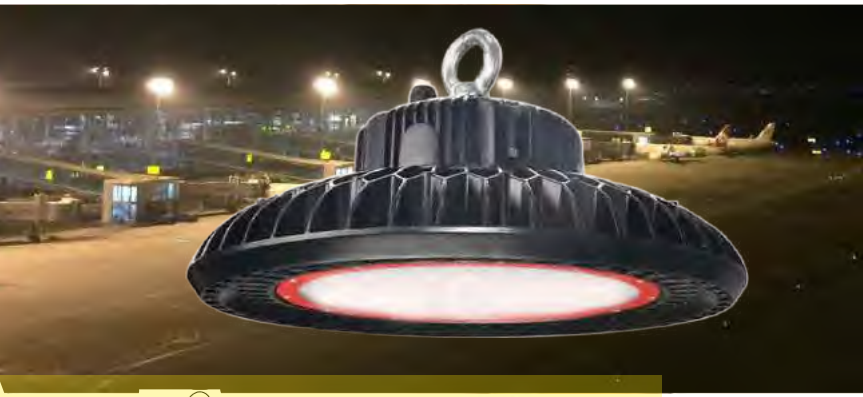
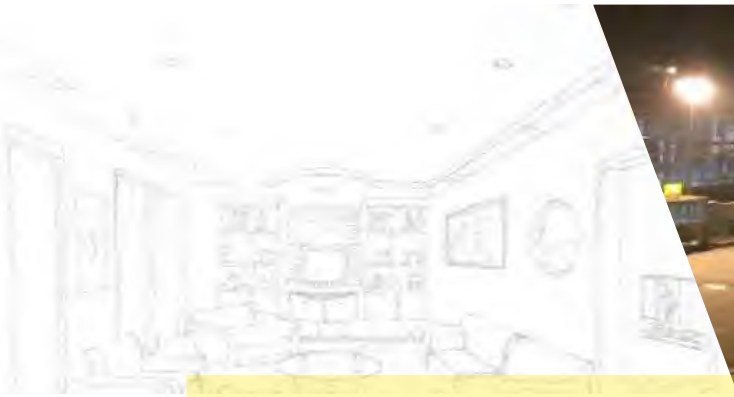

Features 產品特點>>

- ★ Material: aluminum, Clear tempered Glass
- ★ Special heat dissipation structure design
- ★ Using high performance Philips SMD LED(100lm/W)
- ★ Lightweight and easy to install
- ★ Suitable for indoor and outdoor lighting applications
- ★ Certificate: CE RoHS

- ★ 外殼材料: 鋁, 透明鋼化玻璃
- ★ 特殊的散熱結構設計
- ★ 採用高性能飛利浦 SMD LED (100lm / W)
- ★ 質量輕, 方便安裝
- ★ 適用於室內和室外照明應用
- ★ 證書: CE RoHS

Specification 產品規格>>

Model 型號	Voltage 電壓	Power 功率	Lumen 流明	Power factor 功率因數	Colour Temp 色溫	Life Time 壽命	Beam Angle 光束角	Working temperature 工作溫度	IP rating IP等級	Size 尺寸
	(V)	(W)	(lm)	(PF)	(K)	(H)	(°)	(°C)		(mm)
HB-A100-H108F-UFO	85~265	100	10000	>0.9	6000	30,000	120	-20~45	65	280*150

LED, power (W), driver can be customized according to customer needs
 Our Standard Color Rendering (CRI) > 70 and Total harmonic index THD < 15%,
 According to customer requirements can produce a lower THD < 10%
 This type of certification is issued by a government-approved laboratory for Safety
 certification, Fire testing, Restriction of Hazardous Substances (RoHS),
 Photobiological safety of lamps and lamp systems. (an Exemption Group) and other
 test certifications to ensure product quality

LED、功率 (W)、驅動可根據客戶需求定制
 此型號標準之顯色指數 (CRI) > 70, 總諧波指數 THD < 15%, 可按客戶需要生產低總諧波指
 數 < 10%
 此型號認證由可實驗室發出之安全認證消防測試, 環保物料 (RoHS), 光生物安全為
 Exemption Group 及其它測試, 保證客戶使用更安心滿意



東樞LED照明公司
EASTLIKE LED Co., Ltd

Office Address: Room B3, 18/F Bonsun Industrial Building, 364-366 Sha Tsui Road, Tsuen Wan, HongKong
 Phone: 852-39745593 Fax: 852-35440462 info@eastlike.com www.eastlike.com

LED High Bay Light

Series Type: HB-A150-H-UFO

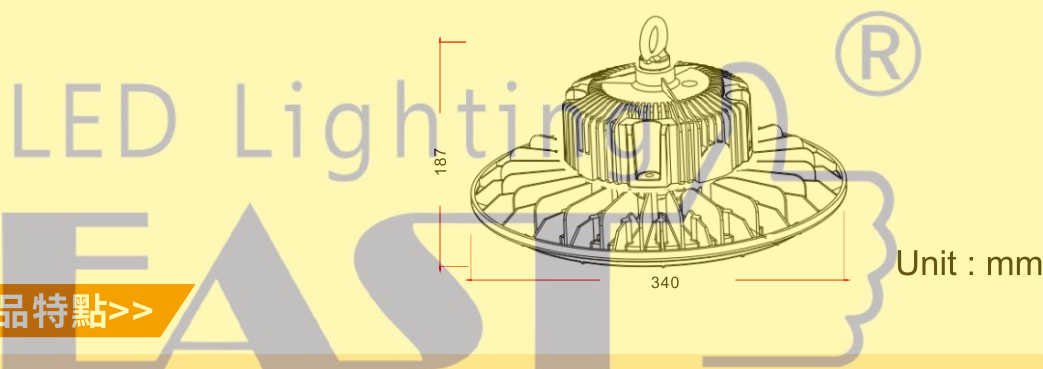
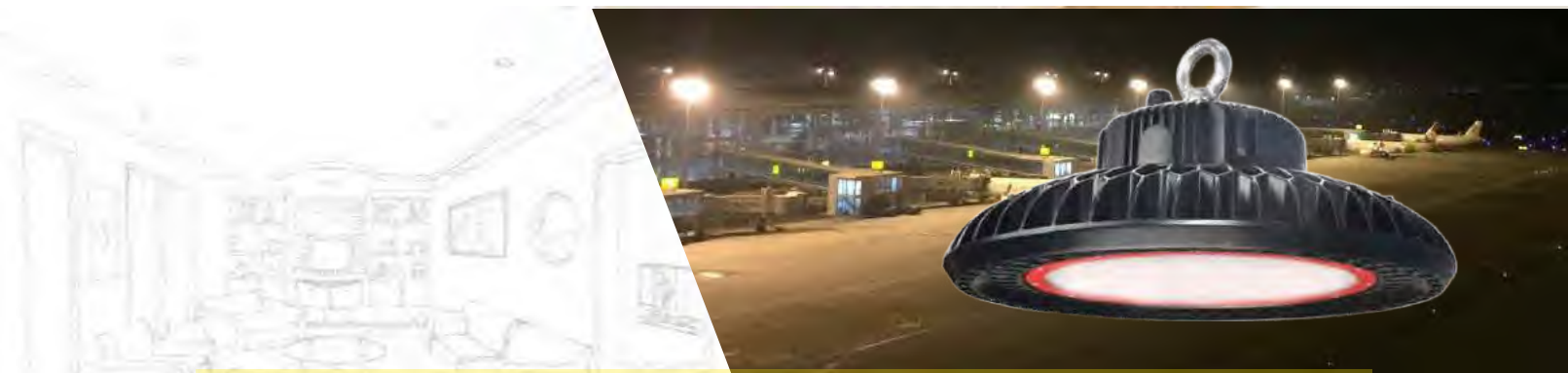

Features 產品特點>>

- ★ Material: aluminum, Clear tempered Glass
 - ★ Special heat dissipation structure design
 - ★ Using high performance Philips SMD LED(100lm/W)
 - ★ Lightweight and easy to install
 - ★ Suitable for indoor and outdoor lighting applications
 - ★ Certificate: CE RoHS
- ★ 外殼材料: 鋁, 透明鋼化玻璃
 - ★ 特殊的散熱結構設計
 - ★ 採用高性能飛利浦 SMD LED (100lm / W)
 - ★ 質量輕, 方便安裝
 - ★ 適用於室內和室外照明應用
 - ★ 證書: CE RoHS

Specification 產品規格>>

Model 型號	Voltage 電壓	Power 功率	Lumen 流明	Power factor 功率因數	Colour Temp 色溫	Life Time 壽命	Beam Angle 光束角	Working temperature 工作溫度	IP rating IP等級	Size 尺寸
	(V)	(W)	(lm)	(PF)	(K)	(H)	(°)	(°C)		(mm)
HB-A150-H108F-UFO	85~265	150	150000	>0.9	6000	30,000	120	-20~45	65	340*187

LED, power (W), driver can be customized according to customer needs
 Our Standard Color Rendering (CRI) > 70 and Total harmonic index THD < 15%,
 According to customer requirements can produce a lower THD < 10%
 This type of certification is issued by a government-approved laboratory for Safety
 certification, Fire testing, Restriction of Hazardous Substances (RoHS),
 Photobiological safety of lamps and lamp systems. (an Exemption Group) and other
 test certifications to ensure product quality

LED、功率 (W)、驅動可根據客戶需求定制
 此型號標準之顯色指數 (CRI) > 70, 總諧波指數 THD < 15%, 可按客戶需要生產低總諧波指
 數 < 10%
 此型號認證由可實驗室發出之安全認證消防測試, 環保物料 (RoHS), 光生物安全為
 Exemption Group 及其它測試, 保證客戶使用更安心滿意



東權 LED 照明公司
 EASTLIKE LED Co., Ltd

Office Address: Room B3, 18/F Bonsun Industrial Building, 364-366 Sha Tsui Road, Tsuen Wan, HongKong
 Phone: 852-39745593 Fax: 852-35440462 info@eastlike.com www.eastlike.com

LED Line Lights

Series Type: IPIL-58

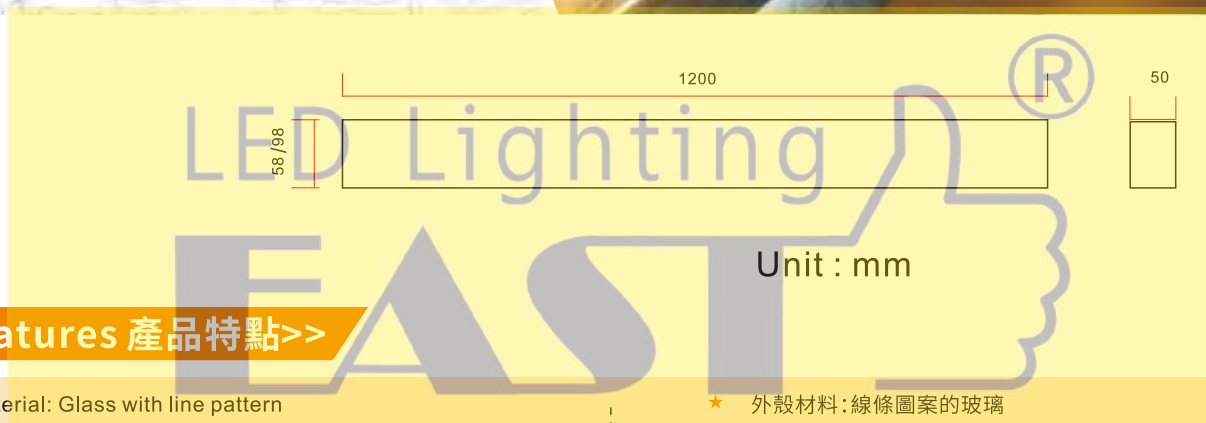

Features 產品特點>>

- ★ Material: Glass with line pattern
 - ★ Special heat dissipation structure design
 - ★ Using the famous Bridgelux COB LED (100lm/W)
 - ★ Ex-d-IIC-T6 explosion-proof grade and WF2 corrosion resistance grade
 - ★ Highly resistant to vibration and shock
 - ★ Suitable for indoor and outdoor lighting applications
 - ★ Certificate: CE RoHS
- ★ 外殼材料: 線條圖案的玻璃
 - ★ 特殊的散熱結構設計
 - ★ 採用著名的Bridgelux COB LED (100lm / W)
 - ★ Ex-d-IIC-T6防爆等級和WF2耐腐蝕等級
 - ★ 高度抗振動和衝擊
 - ★ 適用於室內和室外照明應用
 - ★ 證書: CE RoHS

Specification 產品規格>>

Model 型號	Voltage 電壓	Power 功率	Lumen 流明	Power factor 功率因數	Colour Temp 色溫	Life Time 壽命	Beam Angle 光束角	Working temperature 工作溫度	IP rating IP等級	Size 尺寸
	(V)	(W)	(lm)	(PF)	(K)	(H)	(°)	(°C)		(mm)
IPIL-58	85~265	36	3600	>0.9	3000/4000/6000	30,000	120	-20~45	20	58*1200*50
IPIL-98	85~265	48	4800	>0.9	3000/4000/6000	30,000	120	-20~45	20	98*1200*50

LED, power (W), driver can be customized according to customer needs
 Our Standard Color Rendering (CRI) > 70 and Total harmonic index THD < 15%,
 According to customer requirements can produce a lower THD < 10%
 This type of certification is issued by a government-approved laboratory for Safety
 certification, Fire testing, Restriction of Hazardous Substances (RoHS),
 Photobiological safety of lamps and lamp systems. (an Exemption Group) and other
 test certifications to ensure product quality

LED、功率 (W)、驅動可根據客戶需求定制
 此型號標準之顯色指數 (CRI) > 70, 總諧波指數 THD < 15%, 可按客戶需要生產低總諧波指
 數 < 10%
 此型號認證由可實驗室發出之安全認證消防測試, 環保物料 (RoHS), 光生物安全為
 Exemption Group 及其它測試, 保證客戶使用更安心滿意



東權LED照明公司
EASTLIKE LED Co., Ltd

Office Address: Room B3, 18/F Bonsun Industrial Building, 364-366 Sha Tsui Road, Tsuen Wan, HongKong
 Phone: 852-39745593 Fax: 852-35440462 info@eastlike.com www.eastlike.com

LED Line Lights

Series Type:SL-A-H

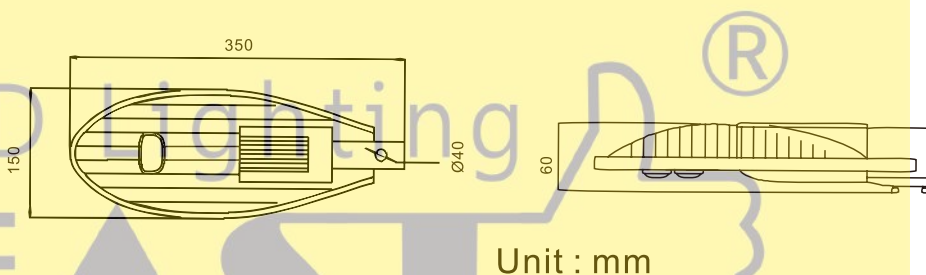

Features 產品特點>>

- ★ Material: Tempered Glass,Clear
- ★ Using the famous Bridgelux COB LED (100lm/W)
- ★ Instant start, save a lot of energy
- ★ High light efficiency, perfect replacement of traditional street lights
- ★ Beautiful appearance, power saving and durable
- ★ Certificate: CE RoHS

- ★ 材質:透明鋼化玻璃
- ★ 採用著名的Bridgelux COB LED (100lm / W)
- ★ 即時啟動,節省大量能源
- ★ 高光效,完美替代传统路燈
- ★ 外形美觀,省電又耐用
- ★ 證書:CE RoHS

Specification 產品規格>>

Model 型號	Voltage 電壓	Power 功率	Lumen 流明	Power factor 功率因數	Colour Temp 色溫	Life Time 壽命	Beam Angle 光束角	Working temperature 工作溫度	IP rating IP等級	Size 尺寸
	(V)	(W)	(lm)	(PF)	(K)	(H)	(°)	(°C)		(mm)
SL-A10-H108E	85~265	10	1000	>0.9	2700-6500	30,000	120	-25~45	65	350*150*60
SL-A30-H108E	85~265	30	3000	>0.9	2700-6500	30,000	120	-25~45	65	400*170*70
SL-A50-H108E	85~265	50	5000	>0.9	2700-6500	30,000	120	-25~45	65	505*215*95

LED, power (W), driver can be customized according to customer needs
 Our Standard Color Rendering (CRI) > 70 and Total harmonic index THD < 15%,
 According to customer requirements can produce a lower THD < 10%
 This type of certification is issued by a government-approved laboratory for Safety
 certification, Fire testing, Restriction of Hazardous Substances (RoHS),
 Photobiological safety of lamps and lamp systems. (an Exemption Group) and other
 test certifications to ensure product quality

LED、功率 (W)、驅動可根據客戶需求定制
 此型號標準之顯色指數 (CRI) > 70, 總諧波指數 THD < 15%, 可按客戶需要生產低總諧波指數 < 10%
 此型號認證由可實驗室發出之安全認證消防測試, 環保物料 (RoHS), 光生物安全為
 Exemption Group 及其它測試, 保證客戶使用更安心滿意



東權LED照明公司
 EASTLIKE LED Co., Ltd

Office Address: Room B3, 18/F Bonsun Industrial Building, 364-366 Sha Tsui Road, Tsuen Wan, HongKong
 Phone: 852-39745593 Fax: 852-35440462 info@eastlike.com www.eastlike.com

LED Street Light

Series Type:SL-A70-H

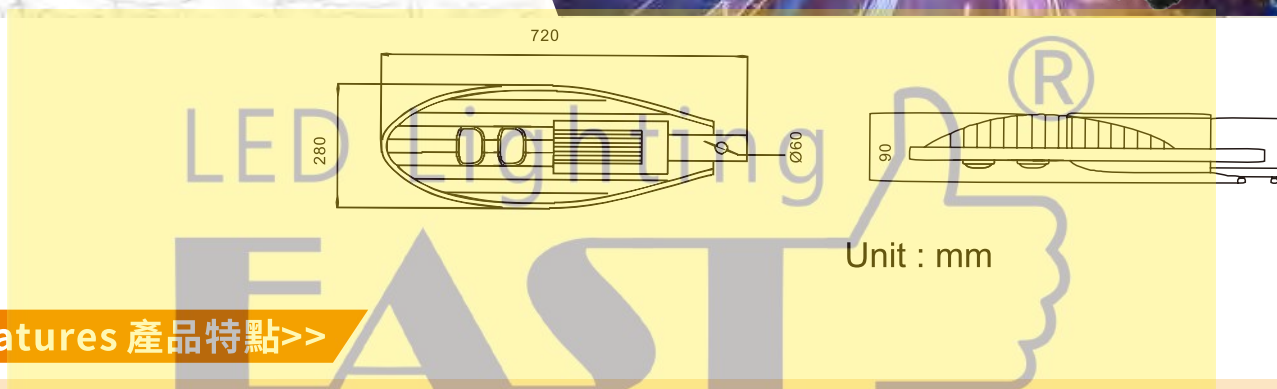

Features 產品特點>>

- ★ Material: Tempered Glass,Clear
- ★ Using the famous Bridgelux COB LED (100lm/W)
- ★ Instant start, save a lot of energy
- ★ High light efficiency, perfect replacement of traditional street lights
- ★ Beautiful appearance, po
- ★ 材質:透明鋼化玻璃
- ★ 採用著名的Bridgelux COB LED (100lm / W)
- ★ 即時啟動,節省大量能源
- ★ 高光效,完美替代传统路灯
- ★ 外形美观,省电又耐用
- ★ 證書:CE RoHS

Specification 產品規格>>

Model 型號	Voltage 電壓	Power 功率	Lumen 流明	Power factor 功率因數	Colour Temp 色溫	Life Time 壽命	Beam Angle 光束角	Working temperature 工作溫度	IP rating IP等級	Size 尺寸
	(V)	(W)	(lm)	(PF)	(K)	(H)	(°)	(°C)		(mm)
SL-A70-H108E	85~265	70	7000	>0.9	2700~6500	30,000	120	-20~45	65	720*280*90
SL-A100-H108E	85~265	100	10000	>0.9	2700~6500	30,000	120	-20~45	65	720*280*90

LED, power (W), driver can be customized according to customer needs
 Our Standard Color Rendering (CRI) > 70 and Total harmonic index THD < 15%,
 According to customer requirements can produce a lower THD < 10%
 This type of certification is issued by a government-approved laboratory for Safety
 certification, Fire testing, Restriction of Hazardous Substances (RoHS),
 Photobiological safety of lamps and lamp systems. (an Exemption Group) and other
 test certifications to ensure product quality

LED、功率(W)、驅動可根據客戶需求定制
 此型號標準之显色指數(CRI)>70, 總諧波指數THD<15%, 可按客戶需要生產低總諧波指
 數<10%
 此型號認證由可實驗室發出之安全認證消防測試, 環保物料 (RoHS), 光生物安全為
 Exemption Group及其它測試, 保證客戶使用更安心滿意



東權LED照明公司
EASTLIKE LED Co., Ltd

Office Address: Room B3, 18/F Bonsun Industrial Building, 364-366 Sha Tsui Road, Tsuen Wan, HongKong
 Phone: 852-39745593 Fax: 852-35440462 info@eastlike.com www.eastlike.com

LED Street Light

Series Type:SL-A150-H

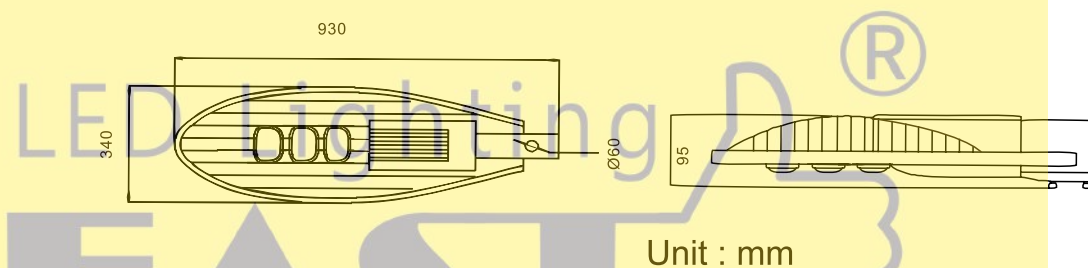

Features 產品特點>>

- ★ Material: Tempered Glass,Clear
- ★ Using the famous Bridgelux COB LED (100lm/W)
- ★ Instant start, save a lot of energy
- ★ High light efficiency, perfect replacement of traditional street lights
- ★ Beautiful appearance, power saving and durable
- ★ Certificate: CE RoHS

- ★ 材質：透明鋼化玻璃
- ★ 採用著名的Bridgelux COB LED (100lm / W)
- ★ 即時啟動，節省大量能源
- ★ 高光效，完美替代传统路灯
- ★ 外形美观，省电又耐用
- ★ 證書：CE RoHS

Specification 產品規格>>

Model 型號	Voltage 電壓	Power 功率	Lumen 流明	Power factor 功率因數	Colour Temp 色溫	Life Time 壽命	Beam Angle 光束角	Working temperature 工作溫度	IP rating IP等級	Size 尺寸
	(V)	(W)	(lm)	(PF)	(K)	(H)	(°)	(°C)		(mm)
SL-A120-H108E	85~265	120	12000	>0.9	2700~6500	30,000	120	-20~45	65	930*340*95
SL-A150-H108E	85~265	150	15000	>0.9	2700~6500	30,000	120	-20~45	65	930*340*95

LED, power (W), driver can be customized according to customer needs
Our Standard Color Rendering (CRI) > 70 and Total harmonic index THD < 15%,
According to customer requirements can produce a lower THD < 10%
This type of certification is issued by a government-approved laboratory for Safety
certification, Fire testing, Restriction of Hazardous Substances (RoHS),
Photobiological safety of lamps and lamp systems. (an Exemption Group) and other
test certifications to ensure product quality

LED、功率 (W)、驅動可根據客戶需求定制
此型號標準之显色指數 (CRI) > 70, 總諧波指數 THD < 15%, 可按客戶需要生產低總諧波指數 < 10%
此型號認證由可實驗室發出之安全認證消防測試, 環保物料 (RoHS), 光生物安全為
Exemption Group 及其它測試, 保證客戶使用更安心滿意



東權LED照明公司
EASTLIKE LED Co., Ltd

Office Address: Room B3, 18/F Bonsun Industrial Building, 364-366 Sha Tsui Road, Tsuen Wan, HongKong
Phone: 852-39745593 Fax: 852-35440462 info@eastlike.com www.eastlike.com

LED Street Light

Series Type:SSL-A

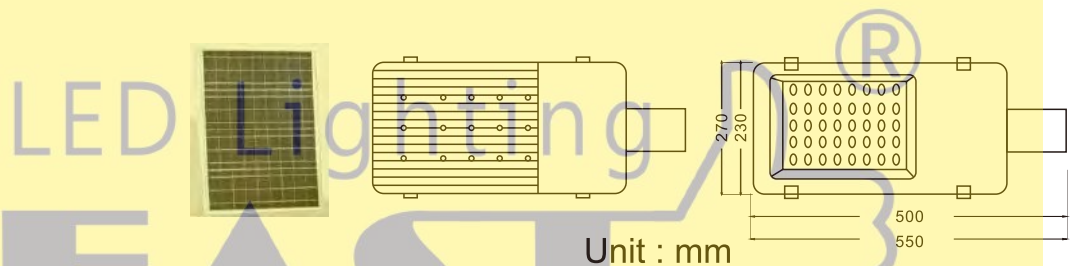

Features 產品特點>>

- ★ Humanized timing control (3 hours 100% Watt, 2 hours 50% Watt, 3 hours 20% Watt, rainy days 2-3 days, this mode can be customized according to customers)
- ★ Max wattage 18V, 80W (high efficiency imported single crystal silicon), ternary lithium battery (11.1V / 48A)
- ★ Installation height: 6m, pole spacing: 25-30m
- ★ Suitable for street, square, park, school, farm, villa, garden, etc

- ★ 人性化的定時控制(3小時100%瓦特,2小時50%瓦特,3小時20%瓦特,雨天2-3天,此模式可根據客戶定制)
- ★ 最大瓦數18V,80W(高效進口單晶矽),三元鋰電池(11.1V / 48AH)
- ★ 安裝高度:6m 桿距:25-30m
- ★ 適用於街道、廣場、公園、學校、農場、別墅、花園等場所的道路照明

Specification 產品規格>>

Model 型號	Voltage 電壓	Power 功率	Lumen 流明	Power factor 功率因數	Colour Temp 色溫	Life Time 壽命	Beam Angle 光束角	Working temperature 工作溫度	IP rating IP等級	Size 尺寸
	(V)	(W)	(lm)	(PF)	(K)	(H)	(°)	(°C)		(mm)
SSL-A30	85~305	30	3000	>0.9	2700-6500	30,000	120	-25~45	65	500*230*70
SSL-A50	85~305	50	5000	>0.9	2700-6500	30,000	120	-25~45	65	550*270*70

LED, power (W), driver can be customized according to customer needs
Our Standard Color Rendering (CRI) > 70 and Total harmonic index THD < 15%,
According to customer requirements can produce a lower THD < 10%
This type of certification is issued by a government-approved laboratory for Safety
certification, Fire testing, Restriction of Hazardous Substances (RoHS),
Photobiological safety of lamps and lamp systems. (an Exemption Group) and other
test certifications to ensure product quality

LED、功率(W)、驅動可根據客戶需求定制
此型號標準之顯色指數(CRI)>70,總諧波指數THD<15%,可按客戶需要生產低總諧波指數<10%
此型號認證由可實驗室發出之安全認證消防測試,環保物料(RoHS),光生物安全為
Exemption Group及其它測試,保證客戶使用更安心滿意



東權LED照明公司
EASTLIKE LED Co., Ltd

Office Address: Room B3, 18/F Bonsun Industrial Building, 364-366 Sha Tsui Road, Tsuen Wan, HongKong
Phone: 852-39745593 Fax: 852-35440462 info@eastlike.com www.eastlike.com



LED Lighting
**Batten
Luminaries**
支架燈盤系列



東權LED照明公司
EASTLIKE LED Co., Ltd

Office Address: Room B3, 18/F Bonsun Industrial Building, 364-366 Sha Tsui Road, Tsuen Wan, HongKong
Phone: 852-39745593 Fax: 852-35440462 info@eastlike.com www.eastlike.com

T8 British Single Battens

Series Type: DBA-S-EN

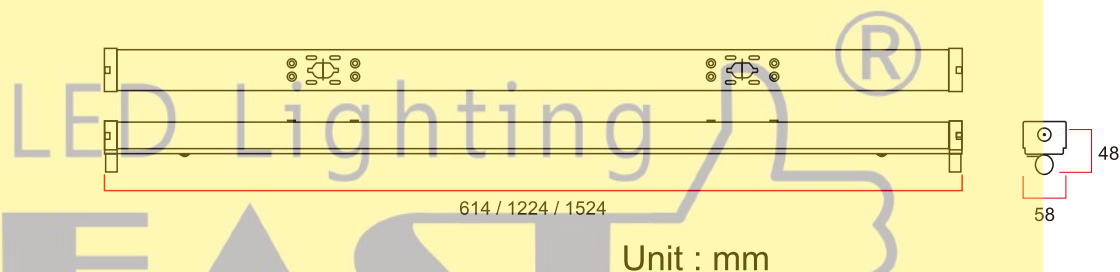

Features 產品特點>>

- ★ The shell adopts arc surface streamline design, beautiful appearance, novel and unique
- ★ Using high-quality cold-rolled steel plate, electrostatic spraying treatment, durable
- ★ The lamp holder adopts a cut-in and rotating design, with tight contact, safe and reliable
- ★ Applicable places: homes, schools, offices, conference rooms, factories, etc
- ★ 外殼採用弧面流線設計, 造型美觀, 新穎獨特
- ★ 採用優質冷軋鋼板, 靜電噴塗處理, 經久耐用
- ★ 燈座採用切入旋轉式設計, 緊緩型接觸, 安全可靠
- ★ 適用場所: 家庭、學校、辦公室、會議室、工廠等

Specification 產品規格>>

Model 型號	Size 尺寸 (mm)	Number Of Tube 燈管數量 (pcs)	Material 材料	IP Grade IP等級	Weight 重量 (kg)	Carton Size 外箱尺寸 (mm)	PCS / CTN 每箱數量 (pcs)
DBA-S06-EN	614*58*48	1pcs*0.6m(2ft)	Cold-rolled steel	IP 20	0.65	620*20*20	8
DBA-S12-EN	1224*58*48	1pcs*1.2m(4ft)	Cold-rolled steel	IP 20	1.29	1230*20*20	8
DBA-S15-EN	1524*58*48	1pcs*1.5m(5ft)	Cold-rolled steel	IP 20	1.52	1530*20*20	8

The product is a separate bracket, which can be equipped with LED tube as required
Lamp light effect (lm/W), power (W), color rendering index (CRI), length, can be customized according to customer needs

產品為单独支架, 可按需求配備LED燈管
燈管光效 (lm/W)、功率 (W)、顯色指數 (CRI)、長度, 可根據客戶需求定制



東樞LED照明公司
EASTLIKE LED Co., Ltd

Office Address: Room B3, 18/F Bonsun Industrial Building, 364-366 Sha Tsui Road, Tsuen Wan, HongKong
Phone: 852-39745593 Fax: 852-35440462 info@eastlike.com www.eastlike.com

T8 British Double Battens

Series Type: DBA-D-EN



Features 產品特點>>

- ★ The shell adopts arc surface streamline design, beautiful appearance, novel and unique
 - ★ Using high-quality cold-rolled steel plate, electrostatic spraying treatment, durable
 - ★ The lamp holder adopts a cut-in and rotating design, with tight contact, safe and reliable
 - ★ Applicable places: homes, schools, offices, conference rooms, factories, etc
- ★ 外殼採用弧面流線設計，造型美觀，新穎獨特
 - ★ 採用優質冷軋鋼板，靜電噴塗處理，經久耐用
 - ★ 燈座採用切入旋轉式設計，緊緩型接觸，安全可靠
 - ★ 適用場所：家庭、學校、辦公室、會議室、工廠等

Specification 產品規格>>

Model 型號	Size 尺寸 (mm)	Number Of Tube 燈管數量 (pcs)	Material 材料	IP Grade IP等級	Weight 重量 (kg)	Carton Size 外箱尺寸 (mm)	PCS / CTN 每箱數量 (pcs)
DBA-D06-EN	614*85*48	2pcs*0.6m(2ft)	Cold-rolled steel	IP 20	0.66	64*20*20	8
DBA-D12-EN	1224*85*50	2pcs*1.2m(4ft)	Cold-rolled steel	IP 20	1.3	124*20*20	8
DBA-D15-EN	1524*85*48	2pcs*1.5m(5ft)	Cold-rolled steel	IP 20	1.53	154*20*20	8

The product is a separate bracket, which can be equipped with LED tube as required
Lamp light effect (lm/W), power (W), color rendering index (CRI), length, can be customized according to customer needs

產品為單獨支架，可按需求配備LED燈管
燈管光效 (lm/W)、功率 (W)、顯色指數 (CRI)、長度，可根據客戶需求定制



東權LED照明公司
EASTLIKE LED Co., Ltd

Office Address: Room B3, 18/F Bonsun Industrial Building, 364-366 Sha Tsui Road, Tsuen Wan, HongKong
Phone: 852-39745593 Fax: 852-35440462 info@eastlike.com www.eastlike.com

NO:5E-6-2-1

T5 British Single Battens

Series Type: DBA-S-EN-T5

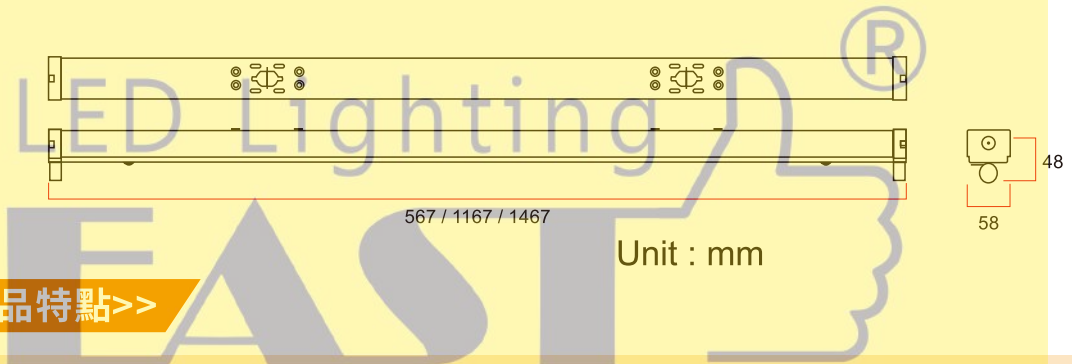

Features 產品特點>>

- ★ The shell adopts arc surface streamline design, beautiful appearance, novel and unique
- ★ Using high-quality cold-rolled steel plate, electrostatic spraying treatment, durable
- ★ The lamp holder adopts a cut-in and rotating design, with tight contact, safe and reliable
- ★ Applicable places: homes, schools, offices, conference rooms, factories, etc

- ★ 外殼採用弧面流線設計，造型美觀，新穎獨特
- ★ 採用優質冷軋鋼板，靜電噴塗處理，經久耐用
- ★ 燈座採用切入旋轉式設計，緊緩型接觸，安全可靠
- ★ 適用場所：家庭、學校、辦公室、會議室、工廠等

Specification 產品規格>>

Model 型號	Size 尺寸 (mm)	Number Of Tube 燈管數量 (pcs)	Material 材料	IP Grade IP等級	Weight 重量 (kg)	Carton Size 外箱尺寸 (mm)	PCS / CTN 每箱數量 (pcs)
DBA-S06-EN-T5	567*58*48	1pcs*0.6m(2ft)	Cold-rolled steel	IP 20	0.62	60*20*20	8
DBA-S12-EN-T5	1167*58*48	1pcs*1.2m(4ft)	Cold-rolled steel	IP 20	1.26	120*20*20	8
DBA-S15-EN-T5	1467*58*48	1pcs*1.5m(5ft)	Cold-rolled steel	IP 20	1.5	150*20*20	8

The product is a separate bracket, which can be equipped with LED tube as required
Lamp light effect (lm/W), power (W), color rendering index (CRI), length, can be customized according to customer needs

產品為单独支架，可按需求配備LED燈管
燈管光效 (lm/W)、功率 (W)、顯色指數 (CRI)、長度，可根據客戶需求定制



東樞LED照明公司
EASTLIKE LED Co., Ltd

Office Address: Room B3, 18/F Bonsun Industrial Building, 364-366 Sha Tsui Road, Tsuen Wan, HongKong
Phone: 852-39745593 Fax: 852-35440462 info@eastlike.com www.eastlike.com

NO:5E-6-3-1

T5 British Double Battens

Series Type: DBA-D-EN-T5

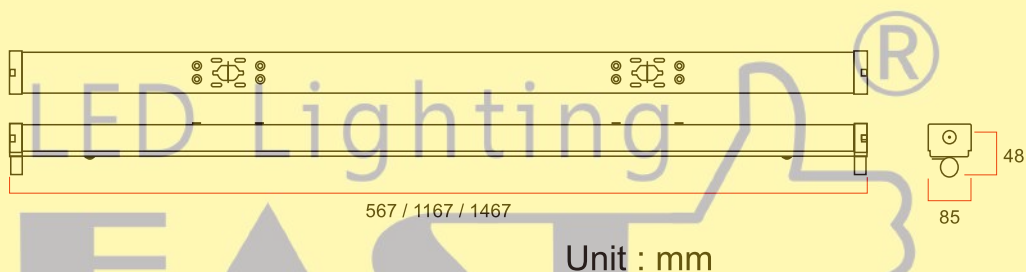

Features 產品特點>>

- ★ The shell adopts arc surface streamline design, beautiful appearance, novel and unique
- ★ Using high-quality cold-rolled steel plate, electrostatic spraying treatment, durable
- ★ The lamp holder adopts a cut-in and rotating design, with tight contact, safe and reliable
- ★ Applicable places: homes, schools, offices, conference rooms, factories, etc

- ★ 外殼採用弧面流線設計, 造型美觀, 新穎獨特
- ★ 採用優質冷軋鋼板, 靜電噴塗處理, 經久耐用
- ★ 燈座採用切入旋轉式設計, 緊緩型接觸, 安全可靠
- ★ 適用場所: 家庭、學校、辦公室、會議室、工廠等

Specification 產品規格>>

Model 型號	Size 尺寸 (mm)	Number Of Tube 燈管數量 (pcs)	Material 材料	IP Grade IP等級	Weight 重量 (kg)	Carton Size 外箱尺寸 (mm)	PCS / CTN 每箱數量 (pcs)
DBA-D06-EN-T5	567*85*48	2pcs*0.6m(2ft)	Cold-rolled steel	IP 20	0.63	580*20*20	8
DBA-D12-EN-T5	1167*85*50	2pcs*1.2m(4ft)	Cold-rolled steel	IP 20	1.27	1180*20*20	8
DBA-D15-EN-T5	1467*85*48	2pcs*1.5m(5ft)	Cold-rolled steel	IP 20	1.5	1480*20*20	8

The product is a separate bracket, which can be equipped with LED tube as required
Lamp light effect (lm/W), power (W), color rendering index (CRI), length, can be customized according to customer needs

產品為单独支架, 可按需求配備LED燈管
燈管光效 (lm/W)、功率 (W)、顯色指數 (CRI)、長度, 可根據客戶需求定制



東樞LED照明公司
EASTLIKE LED Co., Ltd

Office Address: Room B3, 18/F Bonsun Industrial Building, 364-366 Sha Tsui Road, Tsuen Wan, HongKong
Phone: 852-39745593 Fax: 852-35440462 info@eastlike.com www.eastlike.com

NO:5E-6-4-1

T8 Single Slat With Cover

Series Type: DBA-S-CY

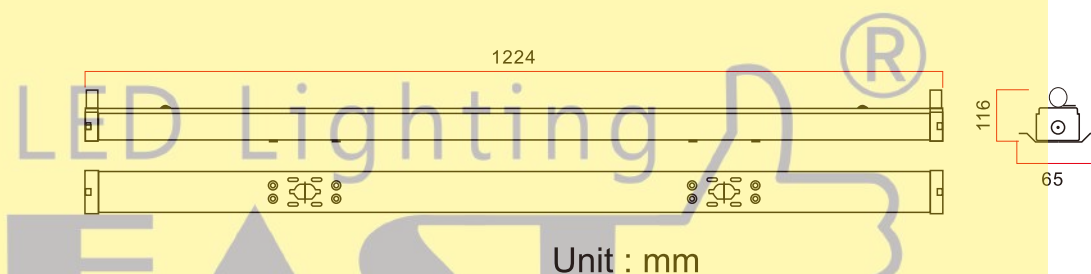

Features 產品特點>>

- ★ The shell adopts arc surface streamline design, beautiful appearance, novel and unique
 - ★ Using high-quality cold-rolled steel plate, electrostatic spraying treatment, durable
 - ★ The lamp holder adopts a cut-in and rotating design, with tight contact, safe and reliable
 - ★ Applicable places: homes, schools, offices, conference rooms, factories, etc
- ★ 外殼採用弧面流線設計, 造型美觀, 新穎獨特
 - ★ 採用優質冷軋鋼板, 靜電噴塗處理, 經久耐用
 - ★ 燈座採用切入旋轉式設計, 緊緩型接觸, 安全可靠
 - ★ 適用場所: 家庭、學校、辦公室、會議室、工廠等

Specification 產品規格>>

Model 型號	Size 尺寸 (mm)	Number Of Tube 燈管數量 (pcs)	Material 材料	IP Grade IP等級	Weight 重量 (kg)	Carton Size 外箱尺寸 (mm)	PCS / CTN 每箱數量 (pcs)
DBA-S1218-CY	1224*116*65	1pcs*1.2m(2ft)	Cold-rolled steel	IP 20	1.4	1230*20*20	6

The product is a separate bracket, which can be equipped with LED tube as required
Lamp light effect (lm/W), power (W), color rendering index (CRI), length, can be customized according to customer needs

產品為单独支架, 可按需求配備LED燈管
燈管光效 (lm/W)、功率 (W)、顯色指數 (CRI)、長度, 可根據客戶需求定制



東樞LED照明公司
EASTLIKE LED Co., Ltd

Office Address: Room B3, 18/F Bonsun Industrial Building, 364-366 Sha Tsui Road, Tsuen Wan, HongKong
Phone: 852-39745593 Fax: 852-35440462 info@eastlike.com www.eastlike.com

NO:5E-6-5-1

T8 Double Slats With Cover

Series Type: DBA-D-Y

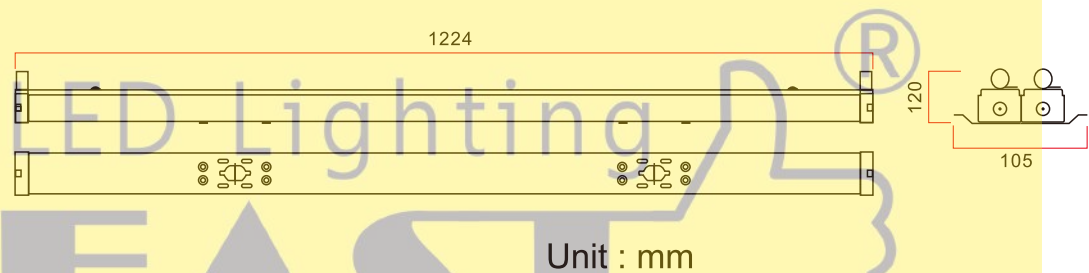

Features 產品特點>>

- ★ The shell adopts arc surface streamline design, beautiful appearance, novel and unique
- ★ Using high-quality cold-rolled steel plate, electrostatic spraying treatment, durable
- ★ The lamp holder adopts a cut-in and rotating design, with tight contact, safe and reliable
- ★ Applicable places: homes, schools, offices, conference rooms, factories, etc
- ★ 外殼採用弧面流線設計，造型美觀，新穎獨特
- ★ 採用優質冷軋鋼板，靜電噴塗處理，經久耐用
- ★ 燈座採用切入旋轉式設計，緊緩型接觸，安全可靠
- ★ 適用場所：家庭、學校、辦公室、會議室、工廠等

Specification 產品規格>>

Model 型號	Size 尺寸 (mm)	Number Of Tube 燈管數量 (pcs)	Material 材料	IP Grade IP等級	Weight 重量 (kg)	Carton Size 外箱尺寸 (mm)	PCS / CTN 每箱數量 (pcs)
DBA-D1236-Y	1224*120*105	1pcs*0.6m(2ft)	Cold-rolled steel	IP 20	2	1230*20*20	4

The product is a separate bracket, which can be equipped with LED tube as required
Lamp light effect (lm/W), power (W), color rendering index (CRI), length, can be customized according to customer needs

產品為单独支架，可按需求配備LED燈管
燈管光效 (lm/W)、功率 (W)、顯色指數 (CRI)、長度，可根據客戶需求定制



東樞LED照明公司
EASTLIKE LED Co., Ltd

Office Address: Room B3, 18/F Bonsun Industrial Building, 364-366 Sha Tsui Road, Tsuen Wan, HongKong
Phone: 852-39745593 Fax: 852-35440462 info@eastlike.com www.eastlike.com

NO:5E-6-6-1

T8 Single Dustproof Battens

Series Type: DBA-S-N

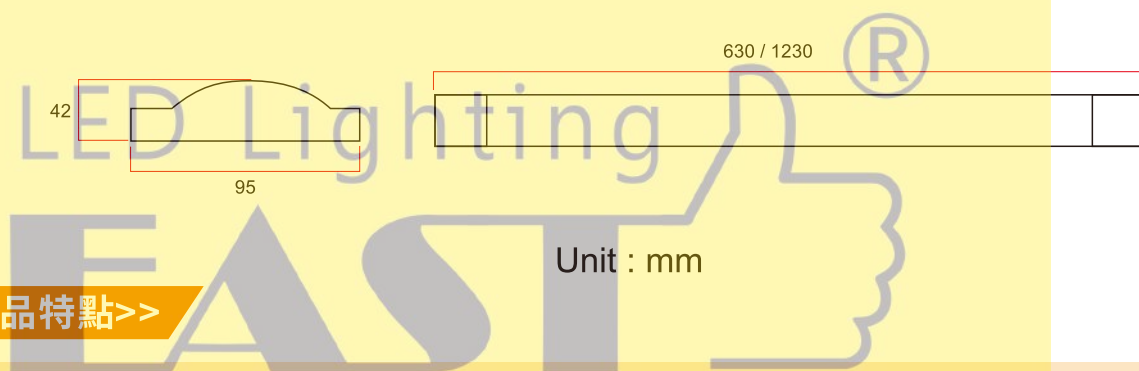

Features 產品特點>>

- ★ The shell adopts arc surface streamline design, beautiful appearance, novel and unique
- ★ Using high-quality cold-rolled steel plate, electrostatic spraying treatment, durable
- ★ The lamp holder adopts a cut-in and rotating design, with tight contact, safe and reliable
- ★ Applicable places: homes, schools, offices, conference rooms, factories, etc
- ★ Installation mode: ceiling installation or suspension installation

- ★ 外殼採用弧面流線設計, 造型美觀, 新穎獨特
- ★ 採用優質冷軋鋼板, 靜電噴塗處理, 經久耐用
- ★ 燈座採用切入旋轉式設計, 緊緩型接觸, 安全可靠
- ★ 適用場所: 家庭、學校、辦公室、會議室、工廠等
- ★ 安裝方式: 吸頂安裝或懸掛安裝

Specification 產品規格>>

Model 型號	Size 尺寸 (mm)	Number Of Tube 燈管數量 (pcs)	Material 材料	IP Grade IP等級	Weight 重量 (kg)	Carton Size 外箱尺寸 (mm)	PCS / CTN 每箱數量 (pcs)
DBA-S0609-N	630*95*42	1pcs*0.6m(2ft)	Iron+PC	IP 20	0.4	660*290*210	12
DBA-S1218-N	1230*95*42	1pcs*1.2m(4ft)	Iron+PC	IP 20	0.8	1260*290*210	12

The product is a separate bracket, which can be equipped with LED tube as required
Lamp light effect (lm/W), power (W), color rendering index (CRI), length, can be customized according to customer needs

產品為單獨支架, 可按需求配備LED燈管
燈管光效 (lm/W)、功率 (W)、顯色指數 (CRI)、長度, 可根據客戶需求定制



東樞LED照明公司
EASTLIKE LED Co., Ltd

Office Address: Room B3, 18/F Bonsun Industrial Building, 364-366 Sha Tsui Road, Tsuen Wan, HongKong
Phone: 852-39745593 Fax: 852-35440462 info@eastlike.com www.eastlike.com

NO:5E-6-9-1

T8 Explosion-proof Single Battens

Series Type: IPB-EPL-G-S

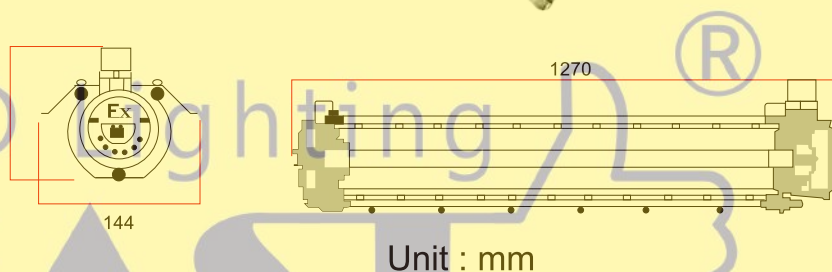

Unit : mm

Features 產品特點>>

- ★ Cast aluminum alloy shell with plastic sprayed surface
- ★ The lamp tube is connected with the end cover by an aluminum support beam. Easy to replace the lamp
- ★ Either steel pipe or cable wiring can be used, and the safety index is high; the structure is light, compact and beautiful
- ★ Suitable for explosive hazardous environments such as power plants, storage, steel, petrochemicals, ships, venues, etc.
- ★ 鑄鋁合金外殼，表面噴塑
- ★ 燈管利用鋁支樑與端蓋連成一體。便於更換燈管
- ★ 鋼管或電纜佈線均可，安全指數高；結構輕巧、美觀大方
- ★ 適用於電廠、儲存、鋼鐵、石化、船舶、場館等爆炸性危險環境

Specification 產品規格>>

Model 型號	Size 尺寸 (mm)	Number Of Tube 燈管數量 (pcs)	Material 材料	IP Grade IP等級	Weight 重量 (kg)	Carton Size 外箱尺寸 (mm)	PCS / CTN 每箱數量 (pcs)
IPB-EPL1218-G66-S	1270*295*144	1pcs*1.2m(4ft)	Steel Die Casting + Tempered Glass	IP 66	3.4	130*31*19	1

The product is a separate bracket, which can be equipped with LED tube as required
Lamp light effect (lm/W), power (W), color rendering index (CRI), length, can be customized according to customer needs

產品為单独支架，可按需求配備LED燈管
燈管光效 (lm/W)、功率 (W)、顯色指數 (CRI)、長度，可根據客戶需求定制



東樞LED照明公司
EASTLIKE LED Co., Ltd

Office Address: Room B3, 18/F Bonsun Industrial Building, 364-366 Sha Tsui Road, Tsuen Wan, HongKong
Phone: 852-39745593 Fax: 852-35440462 info@eastlike.com www.eastlike.com

NO:5E-16-1-1

T8 Explosion-proof Double Battens

Series Type: IPB-EPL-G-D

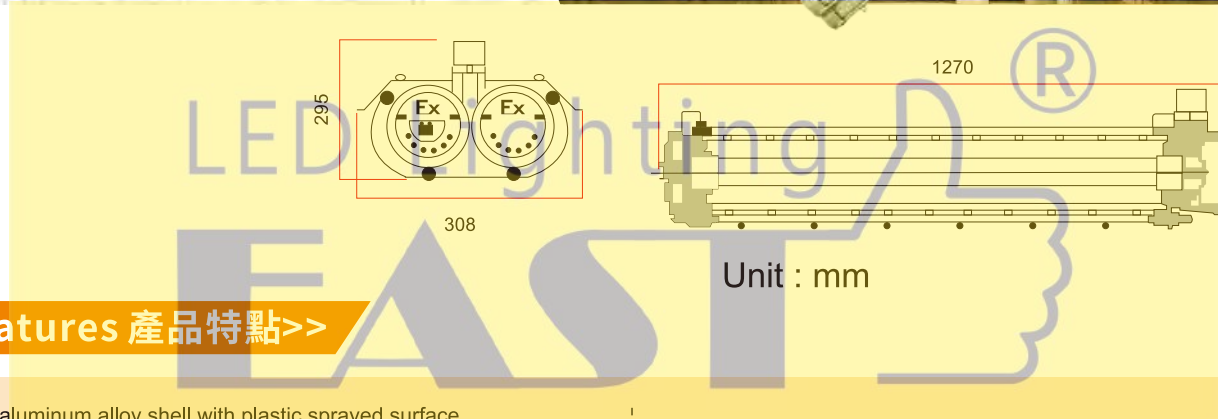

Features 產品特點>>

- ★ Cast aluminum alloy shell with plastic sprayed surface
- ★ The lamp tube is connected with the end cover by an aluminum support beam. Easy to replace the lamp
- ★ Either steel pipe or cable wiring can be used, and the safety index is high; the structure is light, compact and beautiful
- ★ Suitable for explosive hazardous environments such as power plants, storage, steel, petrochemicals, ships, venues, etc.installation

- ★ 鑄鋁合金外殼，表面噴塑
- ★ 燈管利用鋁支樑與端蓋連成一體。便於更換燈管
- ★ 鋼管或電纜佈線均可，安全指數高；結構輕巧、美觀大方
- ★ 適用於電廠、儲存、鋼鐵、石化、船舶、場館等爆炸性危險環境

Specification 產品規格>>

Model 型號	Size 尺寸 (mm)	Number Of Tube 燈管數量 (pcs)	Material 材料	IP Grade IP等級	Weight 重量 (kg)	Carton Size 外箱尺寸 (mm)	PCS / CTN 每箱數量 (pcs)
IPB-EPL1236-G66-D	1270*295*308	2pcs*1.2m(4ft)	Steel Die Casting + Tempered Glass	IP 66	3.8	130*31*32	1

The product is a separate bracket, which can be equipped with LED tube as required
Lamp light effect (lm/W), power (W), color rendering index (CRI), length, can be customized according to customer needs

產品為单独支架，可按需求配備LED燈管
燈管光效 (lm/W)、功率 (W)、顯色指數 (CRI)、長度，可根據客戶需求定制



東樞LED照明公司
EASTLIKE LED Co., Ltd

Office Address: Room B3, 18/F Bonsun Industrial Building, 364-366 Sha Tsui Road, Tsuen Wan, HongKong
Phone: 852-39745593 Fax: 852-35440462 info@eastlike.com www.eastlike.com

T8 Waterproof Double Battens

Series Type: IPBA-1240-M



Features 產品特點>>

- ★ The lamp body design has the functions of dustproof, moisture-proof and waterproof
- ★ Good toughness and strong impact resistance
- ★ With high transmittance and even luminance
- ★ With high thermal conductivity and good heat dissipation
- ★ The lamp body and lampshade are made of polycarbonate (PC), with a locking design, which is easy to disassemble. PC or stainless steel buckles can be used.

- ★ 燈體設計具有防塵, 防潮, 防水功能
- ★ 韌性好, 抗衝擊性強
- ★ 透光率高, 亮度均勻
- ★ 導熱係數高, 散熱好
- ★ 燈體及燈罩是採用聚碳酸料 (PC) 製造, 鎖扣式設計 拆卸方便, 可選用PC或不鏽鋼搭扣

Specification 產品規格>>

Model 型號	Size 尺寸 (mm)	Number Of Tube 燈管數量 (pcs)	Material 材料	IP Grade IP等級	Carton Size 外箱尺寸 (mm)	PCS / CTN 每箱數量 (pcs)
IPBA-1240-M128ETI-M	1265*125*95	2pcs*1.2m(2ft)	PC	IP 65	1285*140*100	4

The product is a separate bracket, which can be equipped with LED tube as required
Lamp light effect (lm/W), power (W), color rendering index (CRI), length, can be customized according to customer needs

產品為单独支架, 可按需求配備LED燈管
燈管光效 (lm/W)、功率 (W)、顯色指數 (CRI)、長度, 可根據客戶需求定制



東樞LED照明公司
EASTLIKE LED Co., Ltd

Office Address: Room B3, 18/F Bonsun Industrial Building, 364-366 Sha Tsui Road, Tsuen Wan, HongKong
Phone: 852-39745593 Fax: 852-35440462 info@eastlike.com www.eastlike.com

T8 Single Waterproof Battens

Series Type: IPB-P-N-S

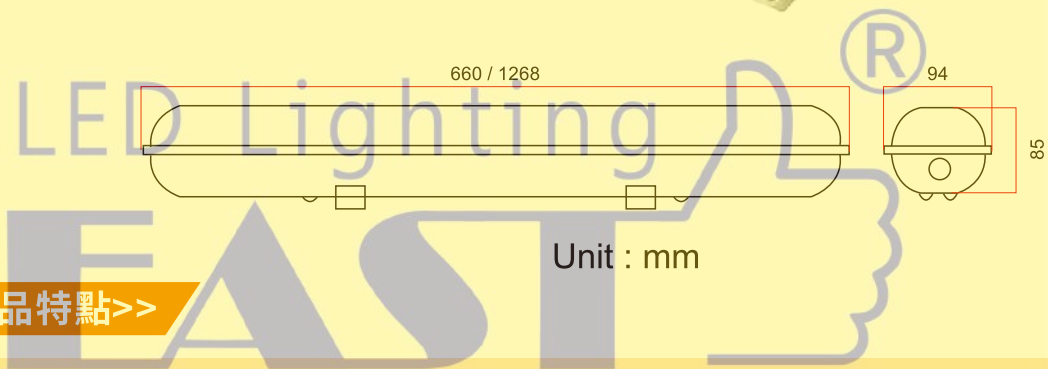

Features 產品特點>>

- ★ Waterproof rating: IP65; certification standard: CE ROHS
 - ★ With waterproof, dust-proof, insect-proof and moisture-proof functions
 - ★ Suitable for T8 and T5 fluorescent tubes, LED tubes
 - ★ Made with the best PC materials, not easy to break, durable
 - ★ Various materials: PC, PS, ABS optional
- ★ 防水等級:IP65;認證標準:CE ROHS
 - ★ 具有防水、防塵、防蟲、防潮功能
 - ★ 適合T8和T5螢光燈管,LED燈管
 - ★ 採用優質PC材料製作,不易破裂,耐用
 - ★ 多種材料:PC、PS、ABS可選

Specification 產品規格>>

Model 型號	Voltage 電壓	Power 功率	Lumen Output 輸出流明	Color Rendering 顯色度	Color Temperature 色溫	Life Time 壽命	Beam Angle 光束角	Operating Temperature 工作溫度	IP Grade IP等級	Size 尺寸
	(V)	(W)	(Lm/W)	(CRI)	(K)	(H)	(°)	(°C)		(mm)
IPB-P0609-N65-S	85~265	1*9	100	>80	2700-6500	30000	120	-20~45	IP 65	660*85*94
IPB-P1218-N65-S	85~265	1*18	100	>80	2700-6500	30000	120	-20~45	IP 65	1268*85*94

The product is a separate bracket, which can be equipped with LED tube as required
Lamp light effect (lm/W), power (W), color rendering index (CRI), length, can be customized according to customer needs

產品為单独支架,可按需求配備LED燈管
燈管光效(lm/W)、功率(W)、顯色指數(CRI)、長度,可根據客戶需求定制



東樞LED照明公司
EASTLIKE LED Co., Ltd

Office Address: Room B3, 18/F Bonsun Industrial Building, 364-366 Sha Tsui Road, Tsuen Wan, HongKong
Phone: 852-39745593 Fax: 852-35440462 info@eastlike.com www.eastlike.com

T8 Double Waterproof Battens

Series Type: IPB-P-N-D

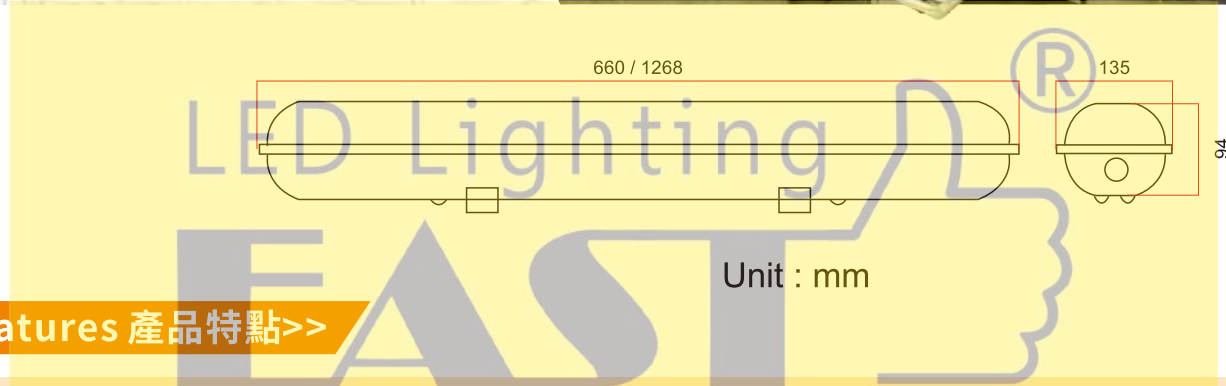

Features 產品特點>>

- | | |
|-----------------------------------------------------------------------------------------------------------------------------------------------------------------------------------------------------------------------------------------------------------------------------------------------------------------------------------------------------------------------------------------|----------------------------------------------------------------------------------------------------------------------------------------------------------------------------------------------|
| <ul style="list-style-type: none"> ★ Waterproof rating: IP65; certification standard: CE ROHS ★ With waterproof, dust-proof, insect-proof and moisture-proof functions ★ Suitable for T8 and T5 fluorescent tubes, LED tubes ★ Made with the best PC materials, not easy to break, durable ★ Various materials: PC, PS, ABS optional | <ul style="list-style-type: none"> ★ 防水等級:IP65;認證標準:CE ROHS ★ 具有防水、防塵、防蟲、防潮功能 ★ 適合T8和T5螢光燈管,LED燈管 ★ 採用優質PC材料製作,不易破裂,耐用 ★ 多種材料:PC、PS、ABS可選 |
|-----------------------------------------------------------------------------------------------------------------------------------------------------------------------------------------------------------------------------------------------------------------------------------------------------------------------------------------------------------------------------------------|----------------------------------------------------------------------------------------------------------------------------------------------------------------------------------------------|

Specification 產品規格>>

Model 型號	Voltage 電壓	Power 功率	Lumen Output 輸出流明	Color Rendering 顯色度	Color Temperature 色溫	Life Time 壽命	Beam Angle 光束角	Operating Temperature 工作溫度	IP Grade IP等級	Size 尺寸
	(V)	(W)	(Lm/W)	(CRI)	(K)	(H)	(°)	(°C)		(mm)
IPB-P0618-N65-D	85~265	2*9	100	>80	2700-6500	30000	120	-20~45	IP 65	660*135*94
IPB-P1236-N65-D	85~265	2*18	100	>80	2700-6500	30000	120	-20~45	IP 65	1268*135*94

The product is a separate bracket, which can be equipped with LED tube as required
Lamp light effect (lm/W), power (W), color rendering index (CRI), length, can be customized according to customer needs

產品為单独支架,可按需求配備LED燈管
燈管光效(lm/W)、功率(W)、顯色指數(CRI)、長度,可根據客戶需求定制



東權LED照明公司
EASTLIKE LED Co., Ltd

Office Address: Room B3, 18/F Bonsun Industrial Building, 364-366 Sha Tsui Road, Tsuen Wan, HongKong
Phone: 852-39745593 Fax: 852-35440462 info@eastlike.com www.eastlike.com

NO:5E-16-6-1

T8 Single Opalescent Mask Battens

Series Type: IPB-TM-N-S

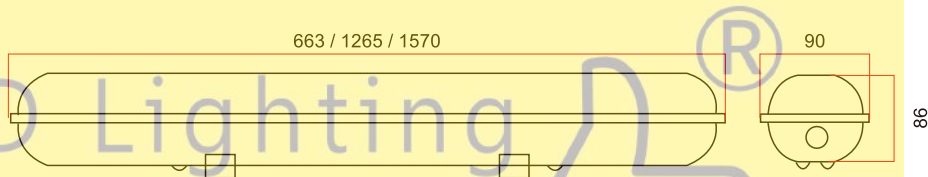

Features 產品特點>>

- ★ The lampshade and lamp body are made of high-quality plastics, which have anti-UV and flame-retardant properties and high mechanical strength
- ★ There are protective coils and waterproof joints at both ends of the lamp body, with good sealing performance and protection level Ip65
- ★ Reasonable light distribution design, soft light, effectively suppress glare, and effectively protect eyesight
- ★ Installation method: Ceiling type, fixed by hanging wire and line pipe hook
- ★ Scope of application: factories, flyovers, basements, parking lots, food courts and other environments

Unit : mm

- ★ 灯罩、灯体由优质塑料制造, 具有防UV和阻燃特性, 机械强度高
- ★ 灯体两端有护线圈和防水接头, 密封性能好, 防护等级IP65
- ★ 合理配光设计, 光线柔和, 有效抑制眩光, 有效的保护视力
- ★ 安装方式: 吸顶式、采用吊线、线管吊钩固定
- ★ 适用范围: 工厂、天桥、地下室、停车场、食品场等环境

Specification 產品規格>>

Model 型號	Size 尺寸 (mm)	Number Of Tube 燈管數量 (pcs)	Material 材料	IP Grade IP等級	Carton Size 外箱尺寸 (mm)	PCS / CTN 每箱數量 (pcs)
IPB-TM0608-N-S	663*86*90	1pcs*0.6m(2ft)	ABS+PC	IP 65	695*285*220	9
IPB-TM1208-N-S	1265*86*90	1pcs*1.2m(4ft)	ABS+PC	IP 65	1295*285*220	9
IPB-TM1508-N-S	1570*86*90	1pcs*1.5m(5ft)	ABS+PC	IP 65	1595*290*300	9

The product is a separate bracket, which can be equipped with LED tube as required
Lamp light effect (lm/W), power (W), color rendering index (CRI), length, can be customized according to customer needs

產品為单独支架, 可按需求配備LED燈管
燈管光效 (lm/W)、功率 (W)、顯色指數 (CRI)、長度, 可根據客戶需求定制



東樞LED照明公司
EASTLIKE LED Co., Ltd

Office Address: Room B3, 18/F Bonsun Industrial Building, 364-366 Sha Tsui Road, Tsuen Wan, HongKong
Phone: 852-39745593 Fax: 852-35440462 info@eastlike.com www.eastlike.com

NO:5E-16-9-1

T8 Double Opalescent Mask Battens

Series Type: IPB-TM-N-D

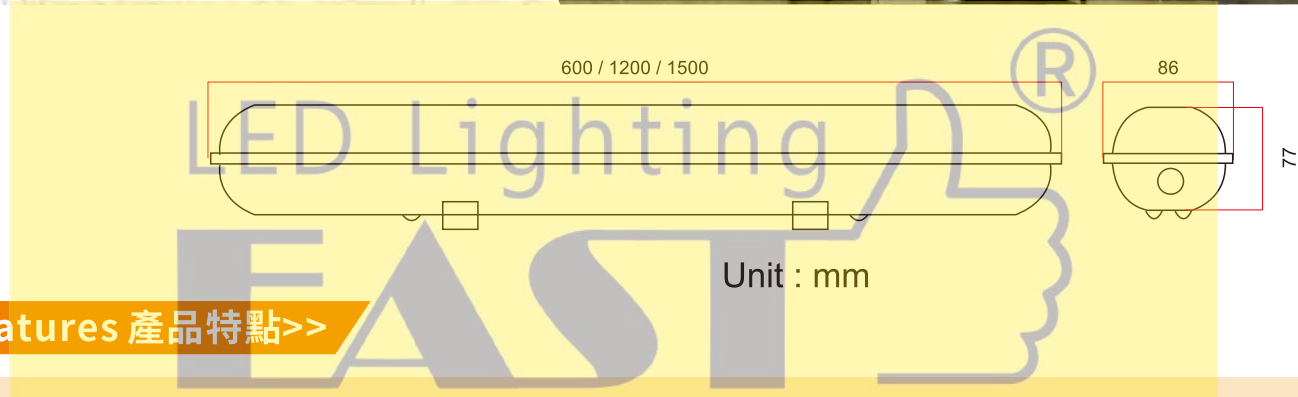

Features 產品特點>>

- ★ The lamp body design has the functions of dustproof, moisture-proof and waterproof
 - ★ Good toughness and strong impact resistance
 - ★ With high transmittance and even luminance
 - ★ With high thermal conductivity and good heat dissipation
 - ★ High elastic rubber ring seal between lamp body and mask, stainless steel clasp
- ★ 燈體設計具有防塵, 防潮, 防水功能
 - ★ 韌性好, 抗衝擊性強
 - ★ 透光率高, 亮度均勻
 - ★ 導熱係數高, 散熱好
 - ★ 燈體與面罩之間採用高彈性橡膠圈密封, 不銹鋼表扣

Specification 產品規格>>

Model 型號	Size 尺寸 (mm)	Number Of Tube 燈管數量 (pcs)	Material 材料	IP Grade IP等級	Carton Size 外箱尺寸 (mm)	PCS / CTN 每箱數量 (pcs)
IPB-TM0608-N-D	660*86*77	2pcs*0.6m(2ft)	PC+PC	IP 65	630*280*255	9
IPB-TM1208-N-D	1200*86*77	2pcs*1.2m(4ft)	PC+PC	IP 65	1230*280*255	9
IPB-TM1508-N-D	1500*86*77	2pcs*1.5m(5ft)	PC+PC	IP 65	1530*280*255	9

The product is a separate bracket, which can be equipped with LED tube as required
Lamp light effect (lm/W), power (W), color rendering index (CRI), length, can be customized according to customer needs

產品為单独支架, 可按需求配備LED燈管
燈管光效 (lm/W)、功率 (W)、顯色指數 (CRI)、長度, 可根據客戶需求定制



東權LED照明公司
EASTLIKE LED Co., Ltd

Office Address: Room B3, 18/F Bonsun Industrial Building, 364-366 Sha Tsui Road, Tsuen Wan, HongKong
Phone: 852-39745593 Fax: 852-35440462 info@eastlike.com www.eastlike.com

NO:5E-16-10-1

T8 Concealed Grille Luminaires

Series Type: GLP-D

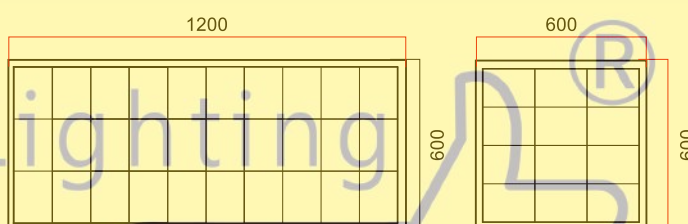

Features 產品特點>>

- ★ The chassis is made of high-quality steel, and the surface is treated by spray molding process
 - ★ The mask is made of Matt aluminum material, with deep arc design, good reflection effect and even and soft light
 - ★ The frame is made of high-quality cold-rolled steel plate, which is resistant to corrosion and rust after degreasing, rust prevention and electrostatic powder spraying
 - ★ Simple shape, strong visual impact
 - ★ Good anti-rust and corrosion performance, not easy to wear, no discoloration, not easy to adhere to dust
- ★ 底盤採用優質鋼材，表面採用噴塑工藝處理
 - ★ 面罩採用亞光鋁材料，深弧形設計，反光效果好，讓光線均勻柔和
 - ★ 邊框採用優質冷軋鋼板，經除油除鏽防油及靜電粉末噴塗處理，防腐耐鏽
 - ★ 造型簡潔，視覺衝擊效果強烈
 - ★ 防銹腐蝕效能好，不易磨損，不變色，不易粘附灰塵

Specification 產品規格>>

Model 型號	Size 尺寸 (mm)	Number Of Tube 燈管數量 (pcs)	Material 材料	IP Grade IP等級	Carton Size 外箱尺寸 (mm)	PCS / CTN 每箱數量 (pcs)
GLP-D0618	300 * 600	2pcs*0.6m(2ft)	Cold-rolled steel	IP 20	64*32*31.5	4
GLP-D1236	300 * 1200	2pcs*1.2m(4ft)	Cold-rolled steel	IP 20	124*32*31.5	4
GLP-D0618	600 * 600	3pcs*0.6m(2ft)	Cold-rolled steel	IP 20	64*32*61	4
GLP-D1236	600 * 1200	3pcs*1.2m(4ft)	Cold-rolled steel	IP 20	124*16.5*61.5	2

The product is a separate bracket, which can be equipped with LED tube as required
Lamp light effect (lm/W), power (W), color rendering index (CRI), length, can be customized according to customer needs

產品為單獨支架，可按需求配備LED燈管
燈管光效 (lm/W)、功率 (W)、顯色指數 (CRI)、長度，可根據客戶需求定制



東樞LED照明公司
EASTLIKE LED Co., Ltd

Office Address: Room B3, 18/F Bonsun Industrial Building, 364-366 Sha Tsui Road, Tsuen Wan, HongKong
Phone: 852-39745593 Fax: 852-35440462 info@eastlike.com www.eastlike.com

T5 Concealed Grille Luminaires

Series Type: GLP-F



298 / 598

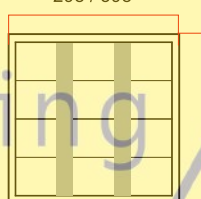

598 / 1198



LED Lighting

Features 產品特點>>

- ★ The chassis is made of high-quality steel, and the surface is treated by spray molding process
- ★ The mask is made of Matt aluminum material, with deep arc design, good reflection effect and even and soft light
- ★ The frame is made of high-quality cold-rolled steel plate, which is resistant to corrosion and rust after degreasing, rust prevention and electrostatic powder spraying
- ★ Simple shape, strong visual impact
- ★ Good anti rust and corrosion performance, not easy to wear, no discoloration, not easy to adhere to dust

Unit : mm

- ★ 底盤採用優質鋼材，表面採用噴塑工藝處理
- ★ 面罩採用亞光鋁材料，深弧形設計，反光效果好，讓光線均勻柔和
- ★ 邊框採用優質冷軋鋼板，經除油除鏽防油及靜電粉末噴塗處理，防腐耐鏽
- ★ 造型簡潔，視覺衝擊效果強烈
- ★ 防銹腐蝕效能好，不易磨損，不變色，不易粘附灰塵

Specification 產品規格>>

Model 型號	Size 尺寸 (mm)	Number Of Tube 燈管數量 (pcs)	Material 材料	IP Grade IP等級	Carton Size 外箱尺寸 (mm)	PCS / CTN 每箱數量 (pcs)
GLP-F0618	598*298*50	2pcs*0.6m(2ft)	Cold-rolled steel	IP 20	610*110*310	2
GLP-F0628	598*598*50	2pcs*1.2m(4ft)	Cold-rolled steel	IP 20	1220*110*310	2
GLP-F1236	1198*298*50	3pcs*0.6m(2ft)	Cold-rolled steel	IP 20	620*110*610	2
GLP-F1248	1198*598*50	3pcs*1.2m(4ft)	Cold-rolled steel	IP 20	1220*110*620	2

The product is a separate bracket, which can be equipped with LED tube as required
Lamp light effect (lm/W), power (W), color rendering index (CRI), length, can be customized according to customer needs

產品為单独支架，可按需求配備LED燈管
燈管光效 (lm/W)、功率 (W)、顯色指數 (CRI)、長度，可根據客戶需求定制



東權LED照明公司
EASTLIKE LED Co., Ltd

Office Address: Room B3, 18/F Bonsun Industrial Building, 364-366 Sha Tsui Road, Tsuen Wan, HongKong
Phone: 852-39745593 Fax: 852-35440462 info@eastlike.com www.eastlike.com

NO:5E-28-3-1

Grille Lamp Panel-1.5m Double

Series Type: GLP-D-N

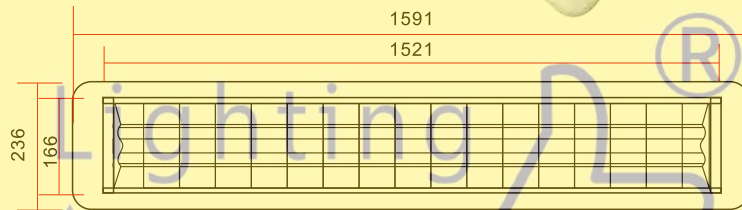

Unit : mm

Features 產品特點>>

- ★ The chassis is made of high-quality steel, and the surface is treated by spray molding process
- ★ The mask is made of Matt aluminum material, with deep arc design, good reflection effect and even and soft light
- ★ The frame is made of high-quality cold-rolled steel plate, which is resistant to corrosion and rust after degreasing, rust prevention and electrostatic powder spraying
- ★ Simple shape, strong visual impact
- ★ Good anti rust and corrosion performance, not easy to wear, no discoloration, not easy to adhere to dust
- ★ 底盤採用優質鋼材，表面採用噴塑工藝處理
- ★ 面罩採用亞光鋁材料，深弧形設計，反光效果好，讓光線均勻柔和
- ★ 邊框採用優質冷軋鋼板，經除油除鏽防油及靜電粉末噴塗處理，耐腐耐鏽
- ★ 造型簡潔，視覺衝擊效果強烈
- ★ 防銹腐蝕效能好，不易磨損，不變色，不易粘附灰塵

Specification 產品規格>>

Model 型號	Size 尺寸 (mm)	Number Of Tube 燈管數量 (pcs)	Material 材料	IP Grade IP等級	Carton Size 外箱尺寸 (mm)	PCS / CTN 每箱數量 (pcs)
GLP-D-N	1591*236*80	2pcs*1.5m(5ft)	Aluminum+SPCC	IP 2020	1610*225*100	2

The product is a separate bracket, which can be equipped with LED tube as required
Lamp light effect (lm/W), power (W), color rendering index (CRI), length, can be customized according to customer needs

產品為单独支架，可按需求配備LED燈管
燈管光效 (lm/W)、功率 (W)、顯色指數 (CRI)、長度，可根據客戶需求定制



東樞LED照明公司
EASTLIKE LED Co., Ltd

Office Address: Room B3, 18/F Bonsun Industrial Building, 364-366 Sha Tsui Road, Tsuen Wan, HongKong
Phone: 852-39745593 Fax: 852-35440462 info@eastlike.com www.eastlike.com



LED Lighting Sensor Application

傳感器應用系列



東權LED照明公司
EASTLIKE LED Co., Ltd

Office Address: Room B3, 18/F Bonsun Industrial Building, 364-366 Sha Tsui Road, Tsuen Wan, HongKong
Phone: 852-39745593 Fax: 852-35440462 info@eastlike.com www.eastlike.com

Sensor Switch

Series Type: MC030SL

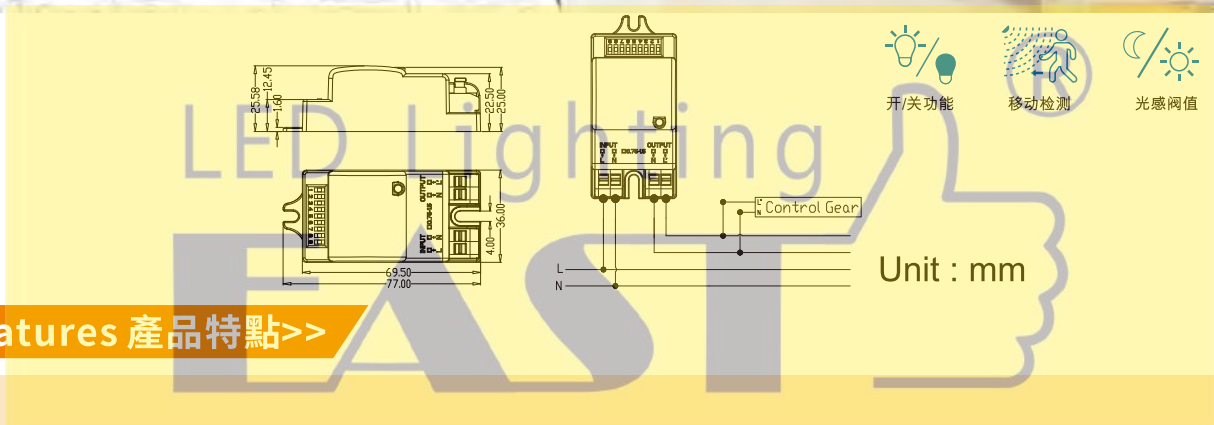

Features 產品特點>>

- ★ Small installation size, easy to install inside the lamp
- ★ Dial code to set sensing distance, sensing delay, light sensing threshold related functions, simple operation
- ★ Double input and output push-type terminals are used to facilitate user wiring
- ★ Bright and dark settings: 2lux/10lux/25lux/50lux/disable

- ★ 安裝尺寸小巧，極易安裝在燈具內部
- ★ 撥碼設置感應距離、感應延時、光感閾值相關功能，操作簡單
- ★ 採用雙輸入輸出按壓式端子，方便用戶接線
- ★ 亮暗設置：2lux/10lux/25lux/50lux/disable

Specification 產品規格>>

Model 型號	Voltage 電壓	Specified Load 額定負載	Transmitting powe 發射功率	Sensing range 感應範圍	Sensing distance 感應距離	Delay time 延遲時間	Operating temp 工作溫度	Size 尺寸
	(V)	(W)	(mW)	(°)	(m)		(°C)	(mm)
IL-MC030SL	185~265	40~300	<0.5	360	6m Max	5S/30S/90S/3min/20min/30min	-20~60	90*42*43

Product specifications, some can be customized according to customer needs

This type of certification is issued by the laboratory for safety certification, fire testing, environmental protection materials (RoHS), photobiological safety for Exemption Group and other tests to ensure that customers are more comfortable and satisfied

產品規格參數，部分可根據客戶需求定制

此型號認證由可實驗室發出之安全認證消防測試，環保物料 (RoHS)，光生物安全為 ExemptionGroup 及其它測試，保證客戶使用更安心滿意



東樞LED照明公司
EASTLIKE LED Co., Ltd

Office Address: Room B3, 18/F Bonsun Industrial Building, 364-366 Sha Tsui Road, Tsuen Wan, HongKong
Phone: 852-39745593 Fax: 852-35440462 info@eastlike.com www.eastlike.com

Sensor Switch

Series Type: MC090SE

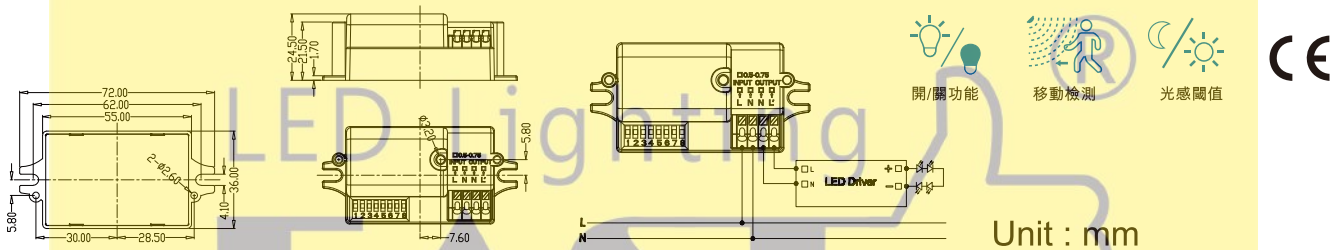

Features 產品特點>>

- ★ It has strong environmental adaptability and can be used in a metal environment. It can resist false triggers such as mosquitoes, birds, and leaf floating
- ★ The infrared light sensing technology is adopted to solve the problem of large deviation of light sensing values on sunny, cloudy, rainy and other days
- ★ Two installation methods (surface and bottom screw installation), suitable for a variety of lamp installations.
- ★ Bright and dark settings: 2lux/10lux/25lux/50lux/disable
- ★ 環境適應性強，可內置於金屬環境中使用，可抵抗蚊蟲、飛鳥、樹葉飄動等誤觸發
- ★ 採用濾除紅外光感技術，解決晴天、陰天、雨天等光感值偏差較大的問題
- ★ 兩種安裝方式（表面和底部螺絲安裝），適用於多種燈具安裝
- ★ 亮暗設置：2lux/10lux/30lux/Disable

Specification 產品規格>>

Model 型號	Voltage 電壓	Specified Load 額定負載	Transmitting power 發射功率	Sensing range 感應範圍	Sensing distance 感應距離	Delay time 延遲時間	Operating temp 工作溫度	Size 尺寸
	(V)	(W)	(mW)	(°)	(m)		(°C)	(mm)
IL-MC090SE	185~265	400	<0.5	360	6-10	5s/30s/60s/3min/5min/10min/20min/30min	-25~55	72*36*24.5

Product specifications, some can be customized according to customer needs

This type of certification is issued by the laboratory for safety certification, fire testing, environmental protection materials (RoHS), photobiological safety for Exemption Group and other tests to ensure that customers are more comfortable and satisfied

產品規格參數，部分可根據客戶需求定制

此型號認證由可實驗室發出之安全認證消防測試，環保物料 (RoHS)，光生物安全為 ExemptionGroup 及其它測試，保證客戶使用更安心滿意



東權LED照明公司
EASTLIKE LED Co., Ltd

Office Address: Room B3, 18/F Bonsun Industrial Building, 364-366 Sha Tsui Road, Tsuen Wan, HongKong
Phone: 852-39745593 Fax: 852-35440462 info@eastlike.com www.eastlike.com

Sensor Switch

Series Type: TR-8031

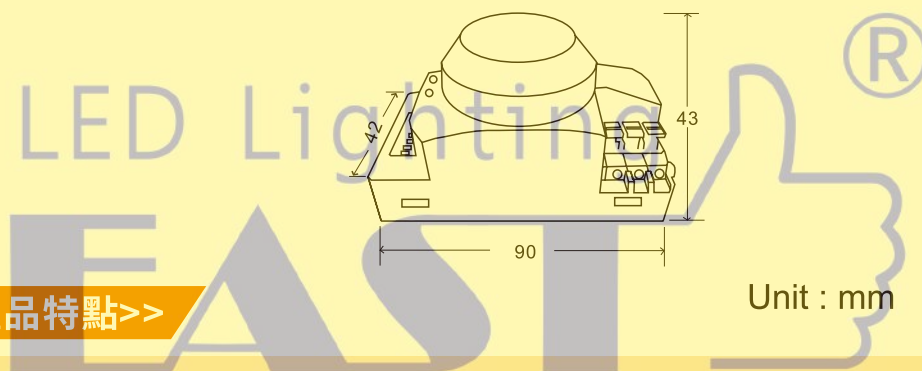

Features 產品特點>>

- ★ Sensitive sensing: distinguish the movement of living and non-living bodies
 - ★ Strong anti-interference: less affected by natural factors, stable performance
 - ★ Safe and practical: using zero-crossing on-off technology, non-contact switch, no spark, low power consumption, long service life
 - ★ Fully automatic induction: automatically turn on the light after sensing a person, the light is on when the person is on, and the light is off when the person is walking, no video flickering, safe power saving
 - ★ Timing control
- ★ 感應靈敏: 準確鑒別生物體與非生物體的運動
 - ★ 抗干擾強: 受外界自然因素影響小, 效能穩定可靠
 - ★ 安全實用: 使用過零通斷科技, 無觸點開關, 不產生火花, 不干擾其他電器, 功耗小, 使用壽命長且能延長負載使用壽命
 - ★ 全自動感應: 感應到人後自動開燈, 人在燈亮、人走燈滅, 無可視頻閃、安全節電, 不受聲、物等外界因素干擾
 - ★ 可定時控制

Specification 產品規格>>

Model 型號	Voltage 電壓	Load Power 負載功率	Transmitting power 發射功率	Sensing range 感應範圍	Sensing distance 感應距離	Delay time 延遲時間	Ambient brightness 環境亮度	Timing Times 定時次數	Size 尺寸
	(V)	(W)	(mW)	(°)	(m)	(min)	(Lux)	(Times)	(mm)
IL-TR-8031	185-265	200 - 800	<0.2	360	1 - 9	≤10	10-1024	16	90*42*43

Product specifications, some can be customized according to customer needs

This type of certification is issued by the laboratory for safety certification, fire testing, environmental protection materials (RoHS), photobiological safety for Exemption Group and other tests to ensure that customers are more comfortable and satisfied

產品規格參數, 部分可根據客戶需求定制

此型號認證由可實驗室發出之安全認證消防測試, 環保物料 (RoHS), 光生物安全為 ExemptionGroup 及其它測試, 保證客戶使用更安心滿意



東攏 LED 照明公司
EASTLIKE LED Co., Ltd

Office Address: Room B3, 18/F Bonsun Industrial Building, 364-366 Sha Tsui Road, Tsuen Wan, HongKong
Phone: 852-39745593 Fax: 852-35440462 info@eastlike.com www.eastlike.com

Sensor Dimmer Switch

Series Type: MC049V/MC083V RC

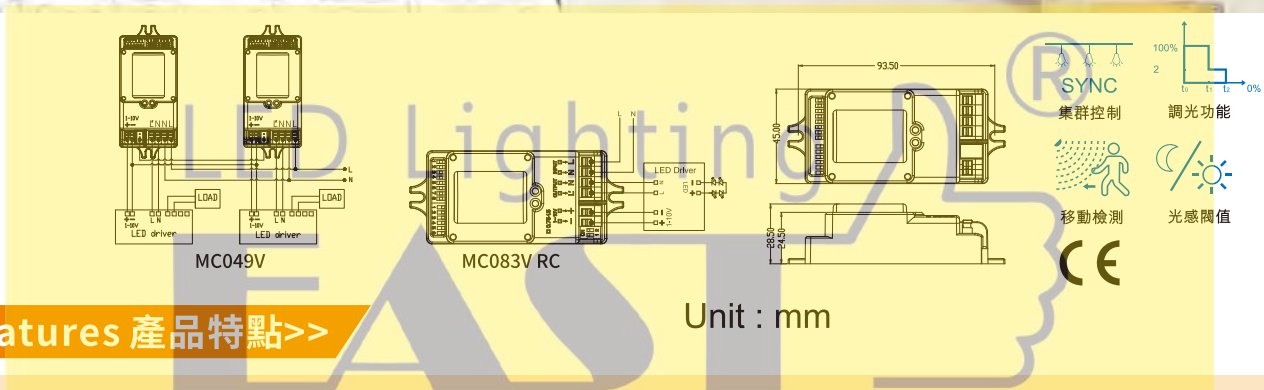

Features 產品特點>>

- ★ Installation height 12m max
- ★ Parameters can be set via the DIP switch (MC049V) or remote control (MC083V Rc)
- ★ Support high and low sense mode, suitable for use in metal ceilings, metal shelves and other warehouses with more metal reflective surfaces
- ★ Switch 3 times (power on/off) to cancel the induction function
- ★ MC049V light and dark settings: 2lux/5lux/10lux/25lux/50lux/100lux/Disable
- ★ MC049V delay setting: 5s/30s/90s/3min/20min/+∞
- ★ MC083V RC brightness setting: 5lux/15lux/50lux/100lux/150lux/Disable(remote) 5lux/15lux/30lux/50lux/100lux/150lux/Disable
- ★ MC083V RC delay setting: 5s/30s/1min/3min/20min/30min(remote) 5s/30s/1min/3min / 5min / 10min / 20min / 30min
- ★ 安裝高度12m max
- ★ 參數可通過撥碼開關 (MC049V) 或者遙控器 (MC083V Rc) 設置
- ★ 支持高低感模式，適合應用在金屬頂棚，金屬貨架等金屬反射面較多的倉庫
- ★ 開關3次 (通電/斷電) 取消感應功能
- ★ MC049V亮暗設置: 2lux / 5lux/10lux/25lux/50lux/100lux/Disable
- ★ MC049V延時設置: 5s/30s/90s/3min/20min/+∞
- ★ MC083V RC亮暗設置: 5lux/15lux/50lux/100lux/150lux/Disable(remote) 5lux/15lux/30lux/50lux/100lux/150lux/Disable
- ★ MC083V RC延時設置: 5s/30s/1min/3min/20min/30min (remote) 5s/30s/1min/ 3min/5min/10min/20min/30min

Specification 產品規格>>

Model 型號	Voltage 電壓	Specified Load 額定負載	Transmitting power 發射功率	Sensing range 感應範圍	Sensing distance 感應距離	Operating temp 工作溫度	Size 尺寸
	(V)	(W)	(mW)	(°)	(m)	(°C)	(mm)
IL-MC049V	185~265	800-1200	<0.5	360	4	-35~60	93.5*45*28.5
IL-MC083V RC	185~265	200-800	<0.5	360	6	-35~60	93.5*45*28.5

Product specifications, some can be customized according to customer needs
This type of certification is issued by the laboratory for safety certification, fire testing, environmental protection materials (RoHS), photobiological safety for Exemption Group and other tests to ensure that customers are more comfortable and satisfied

產品規格參數，部分可根據客戶需求定制
此型號認證由可實驗室發出之安全認證消防測試，環保物料 (RoHS)，光生物安全為 ExemptionGroup及其它測試，保證客戶使用更安心滿意



東樞LED照明公司
EASTLIKE LED Co., Ltd

Office Address: Room B3, 18/F Bonsun Industrial Building, 364-366 Sha Tsui Road, Tsuen Wan, HongKong
Phone: 852-39745593 Fax: 852-35440462 info@eastlike.com www.eastlike.com

Sensor Dimmer Switch

Series Type: MC087V RC

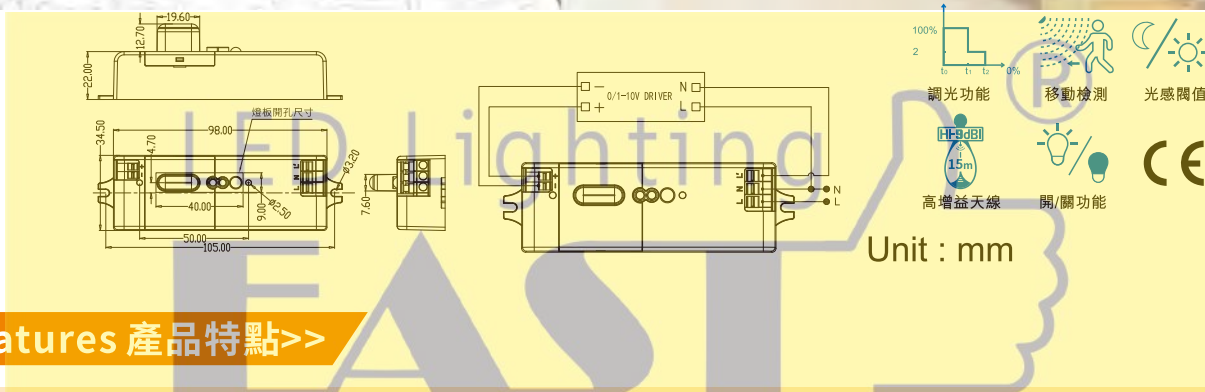

Features 產品特點>>

- ★ The patented dipole antenna effectively solves the blind area problem of the traditional cylindrical antenna and has good anti-interference
- ★ The opening size is 8x20mm, which is suitable for most strip lights
- ★ All parameters can be set via the remote control Mh10.
- ★ Bright and dark settings: Light control priority: ON/OFF Value, (5/15/30/50Lux) / 150Lux, 100Lux / 200Lux, 150Lux / 300Lux
- ★ Delay setting: 5S/30S/1min/3min/5min/10min/20min/30min
- ★ 專利偶極子天線，有效解決了傳統柱狀天線的盲區問題，抗干擾型好
- ★ 開孔尺寸8x20mm，適合絕大多數條形燈
- ★ 所有參數都可以通過遙控器MH10 設置
- ★ 亮暗設置：光控優先：ON/OFF Value, (5/15/30/50Lux) / 150Lux, 100Lux / 200Lux, 150Lux / 300Lux
- ★ 延時設置：5S/30S/1min/3min/5min/10min/20min/30min

Specification 產品規格>>

Model 型號	Voltage 電壓	Transmitting power 發射功率	Sensing range 感應範圍	Sensing distance 感應距離	Operating temp 工作溫度	IP Rating IP等級	Size 尺寸
IL-MC087V RC	185~265 (V)	<0.5 (mW)	360 (°)	>4 (m)	-25~60 (°C)	20 (IP)	105*34.5*22 (mm)

Product specifications, some can be customized according to customer needs

This type of certification is issued by the laboratory for safety certification, fire testing, environmental protection materials (RoHS), photobiological safety for Exemption Group and other tests to ensure that customers are more comfortable and satisfied

產品規格參數，部分可根據客戶需求定制

此型號認證由實驗室發出之安全認證消防測試，環保物料 (RoHS)，光生物安全為 ExemptionGroup 及其它測試，保證客戶使用更安心滿意



東樞LED照明公司
EASTLIKE LED Co., Ltd

Office Address: Room B3, 18/F Bonsun Industrial Building, 364-366 Sha Tsui Road, Tsuen Wan, HongKong
Phone: 852-39745593 Fax: 852-35440462 info@eastlike.com www.eastlike.com

Microwave Sensor LED T8 Tube

Series Type: M

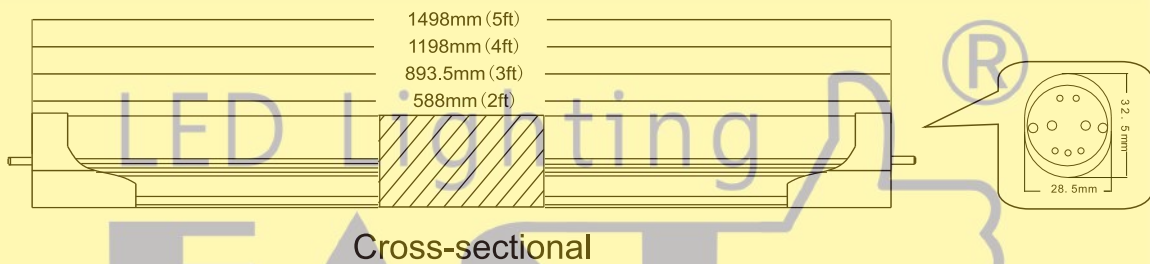

Features 產品特點 >>

- ★ Microwave controlled internal sensor detection distance of 6-8M
- ★ Full lumen in activation mode 30% lumen in standby mode
- ★ Direct replacement of FL tubes in electro-magnetic ballast fitting
- ★ SPM Design – power circuit protection to cut off individual LEDs when mal-functioned
- ★ Exit time 15-60seconds
- ★ Emergency option available: compatible in use with most emergency battery brands & comply with part A11of FSD regulation PPA104
- ★ 微波控制內部感測器,感測器檢測距離6-8米
- ★ 啟動模式下為全流明,待機模式下為30%流明
- ★ 可直接更換電磁鎮流器配件中的FL管
- ★ SPM設計-電源電路保護,當個別led故障時切斷單個LED電路
- ★ 退出時間15-60秒
- ★ 提供應急選項:與大多數應急電池品牌相容,並符合FSD法規PPA104第A11部分

Specification 產品規格 >>

Model 型號	Voltage 電壓 (V)	Wattage 功率 (W)	Length 長度 (mm)	Lamp Life 光度壽命 (Hrs)	Colour Temp 色溫 (K)	Lumen Output 輸出流明 (Lm/W)	Color Rendering 顯色度 (CRI)	Lamp Base 燈腳	PCS/CTN 每箱數量 (pcs)
LT-I0609-M108A	100~240	9	600	30,000	3000/4000/6500	100	>80	T8,G13	25
LT-I0912-M108A	100~240	12	900	30,000	3000/4000/6500	100	>80	T8,G13	25
LT-I1218-M108A	100~240	18	1200	30,000	3000/4000/6500	100	>80	T8,G13	25
LT-I1522-M108A	100~240	22	1500	30,000	3000/4000/6500	100	>80	T8,G13	25

Light efficiency (lm/W), Power (W), Color Rendering Index (CRI), Can be customized according to customer needs

Our Standard Power factor (PF) > 0.9 and Total harmonic index THD < 15%, According to customer requirements can produce a lower THD < 10%

This type of certification is issued by a government-approved laboratory for Safety certification, Fire testing, Restriction of Hazardous Substances (RoHS), Photobiological safety of lamps and lamp systems. (an Exemption Group) and other test certifications to ensure product quality

光效 (lm/W)、功率 (W)、顯色指數 (CRI), 可根據客戶需求定制

此型號標準之功率因素 (PF) > 0.9, 總諧波指數 THD < 15%, 可按客戶需要生產低總諧波指數 < 10%

此型號認證由可實驗室發出之安全認證消防測試, 環保物料 (RoHS), 光生物安全為 Exemption Group 及其它測試, 保證客戶使用更安心滿意



東權 LED 照明公司
EASTLIKE LED Co., Ltd

Office Address: Room B3, 18/F Bonsun Industrial Building, 364-366 Sha Tsui Road, Tsuen Wan, HongKong
Phone: 852-39745593 Fax: 852-35440462 info@eastlike.com www.eastlike.com

Infrared Sensor LED T8 Tube

Series Type: IR

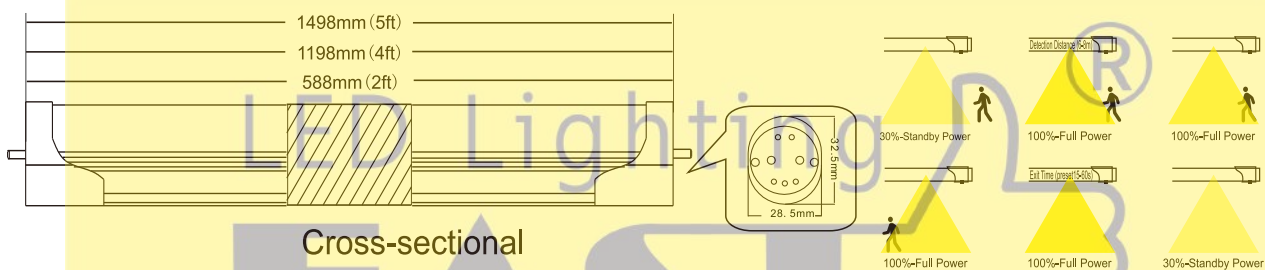

Cross-sectional

Features 產品特點>>

- ★ Uniform light emission
- ★ High luminous output & low power consumption
- ★ SPM design – Power circuit protection to cut off individual LEDs when mal-functioned
- ★ Exit Time 15-60 seconds
- ★ Detection distance(6-8m)

- ★ 發光均勻
- ★ 高流明輸出的同時低功耗
- ★ SPM設計即電源電路保護，在故障時可立即切斷單個LED電路
- ★ 退出時間15-60秒
- ★ 探測距離(6-8米)

Specification 產品規格>>

Model 型號	Voltage 電壓 (V)	Wattage 功率 (W)	Length 長度 (mm)	Lamp Life 光度壽命 (Hrs)	Colour Temp 色溫 (K)	Lumen Output 輸出流明 (Lm/W)	Color Rendering 顯色度 (CRI)	PCS/CTN 每箱數量 (pcs)
LT-I0609-IR108A	100~240	9	600	30,000	6000	100	>80	25
LT-I1218-IR108A	100~240	18	1200	30,000	6000	100	>80	25
LT-I1522-IR108A	100~240	22	1500	30,000	6000	100	>80	25

Light efficiency (lm/W), Power (W), Color Rendering Index (CRI), Can be customized according to customer needs

Our Standard Power factor (PF) > 0.9 and Total harmonic index THD < 15%, According to customer requirements can produce a lower THD < 10%

This type of certification is issued by a government-approved laboratory for Safety certification, Fire testing, Restriction of Hazardous Substances (RoHS), Photobiological safety of lamps and lamp systems. (an Exemption Group) and other test certifications to ensure product quality

光效 (lm/W)、功率 (W)、顯色指數 (CRI)，可根據客戶需求定制

此型號標準之功率因素 (PF) > 0.9，總諧波指數 THD < 15%，可按客戶需要生產低總諧波指數 < 10%

此型號認證由可實驗室發出之安全認證消防測試，環保物料 (RoHS)，光生物安全為 Exemption Group 及其它測試，保證客戶使用更安心滿意



東樞LED照明公司
EASTLIKE LED Co., Ltd

Office Address: Room B3, 18/F Bonsun Industrial Building, 364-366 Sha Tsui Road, Tsuen Wan, HongKong
Phone: 852-39745593 Fax: 852-35440462 info@eastlike.com www.eastlike.com

Sound Control LED T8 Tube

Series Type: V

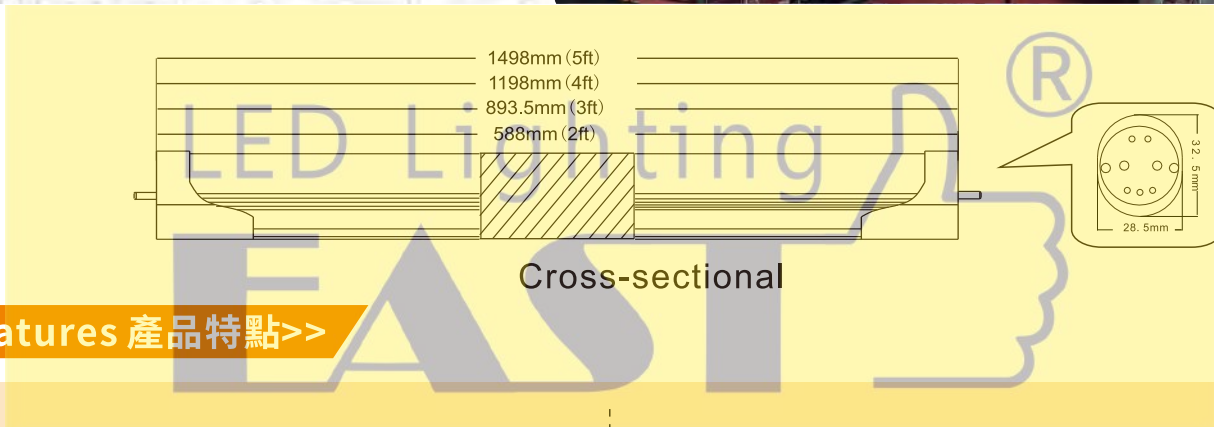

Features 產品特點>>

- ★ Uniform light emission
- ★ SPM design – Power circuit protection to cut off individual LEDs when mal-functioned
- ★ Exit Time 15-60 seconds
- ★ Sound sensitivity 35 - 60B(decibel)
- ★ 發光均勻
- ★ SPM設計即電源電路保護，在故障時可立即切斷單個LED電路
- ★ 退出時間15-60秒
- ★ 聲音靈敏度35-60B(分貝)

Specification 產品規格>>

Model 型號	Voltage 電壓 (V)	Wattage 功率 (W)	Length 長度 (mm)	Lamp Life 光度壽命 (Hrs)	Colour Temp 色溫 (K)	Lumen Output 輸出流明 (Lm/W)	Lamp Base 顯色度 (CRI)	PCS/CTN 每箱數量 (pcs)
LT-I0609-V108A	100~240	9	600	30,000	3000/4000/6500	100	>80	25
LT-I0912-V108A	100~240	12	900	30,000	3000/4000/6500	100	>80	25
LT-I1218-V108A	100~240	18	1200	30,000	3000/4000/6500	100	>80	25
LT-I1522-V108A	100~240	22	1500	30,000	3000/4000/6500	100	>80	25

Light efficiency (lm/W), Power (W), Color Rendering Index (CRI), Can be customized according to customer needs

Our Standard Power factor (PF) > 0.9 and Total harmonic index THD < 15%, According to customer requirements can produce a lower THD < 10%

This type of certification is issued by a government-approved laboratory for Safety certification, Fire testing, Restriction of Hazardous Substances (RoHS), Photobiological safety of lamps and lamp systems. (an Exemption Group) and other test certifications to ensure product quality

光效 (lm/W)、功率 (W)、顯色指數 (CRI)，可根據客戶需求定制

此型號標準之功率因素 (PF) > 0.9，總諧波指數 THD < 15%，可按客戶需要生產低總諧波指數 < 10%

此型號認證由可實驗室發出之安全認證消防測試，環保物料 (RoHS)，光生物安全為 Exemption Group 及其它測試，保證客戶使用更安心滿意



東權 LED 照明公司
EASTLIKE LED Co., Ltd

Office Address: Room B3, 18/F Bonsun Industrial Building, 364-366 Sha Tsui Road, Tsuen Wan, HongKong
Phone: 852-39745593 Fax: 852-35440462 info@eastlike.com www.eastlike.com

Photosensor LED T8 Tube

Series Type: PS

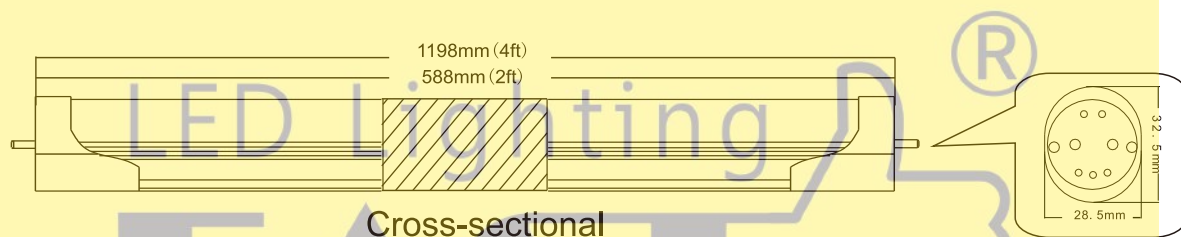

Features 產品特點>>

- ★ Uniform light emission
- ★ Retrofit to existing T8 lights on EM
- ★ SPM Design – power circuit protection to cut off individual LEDs when mal-functioned

Function: the light control probe senses the brightness of the surrounding environment in real time. According to the intensity of the brightness of the environment, it is divided into two sections of light output. When the light is strong, it is output at 30% power (can be designed) and when the light is weak, it is output at 100% power

- ★ 發光均勻
- ★ 對現有的T8燈進行改造
- ★ SPM設計即電源電路保護，在故障時可立即切斷單個LED電路
- ★ 功能：光控探頭實時感應周圍環境亮度，根據環境亮度的強弱分2段光輸出，光線較強時以30%功率（可指定設計）輸出，光線較弱時100%功率輸出

Specification 產品規格>>

Model 型號	Voltage 電壓 (V)	Wattage 功率 (W)	Length 長度 (mm)	Lamp Life 光度壽命 (Hrs)	Colour Temp 色溫 (K)	Lumen Output 輸出流明 (Lm/W)	Color Rendering 顯色度 (CRI)	Lamp Base 燈腳	PCS/CTN 每箱數量 (pcs)
LT-I0609-PS108A	100~240	9	600	30,000	3000/4000/6500	100	>80	T8,G13	25
LT-I1218-PS108A	100~240	18	1200	30,000	3000/4000/6500	100	>80	T8,G13	25

Light efficiency (lm/W), Power (W), Color Rendering Index (CRI), Can be customized according to customer needs

Our Standard Power factor (PF) > 0.9 and Total harmonic index THD < 15%, According to customer requirements can produce a lower THD < 10%

This type of certification is issued by a government-approved laboratory for Safety certification, Fire testing, Restriction of Hazardous Substances (RoHS), Photobiological safety of lamps and lamp systems. (an Exemption Group) and other test certifications to ensure product quality

光效 (lm/W)、功率 (W)、顯色指數 (CRI)，可根據客戶需求定制

此型號標準之功率因素 (PF) > 0.9，總諧波指數 THD < 15%，可按客戶需要生產低總諧波指數 < 10%

此型號認證由可實驗室發出之安全認證消防測試，環保物料 (RoHS)，光生物安全為 Exemption Group 及其它測試，保證客戶使用更安心滿意



東樞 LED 照明公司
EASTLIKE LED Co., Ltd

Office Address: Room B3, 18/F Bonsun Industrial Building, 364-366 Sha Tsui Road, Tsuen Wan, HongKong
Phone: 852-39745593 Fax: 852-35440462 info@eastlike.com www.eastlike.com

Anti Microwave Sensor LED T8 Tube

Series Type: M-AI

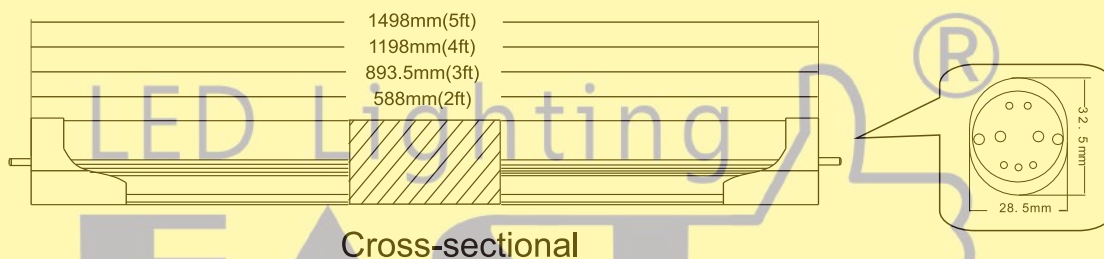

Features 產品特點>>

- ★ Anti-interference design -2 pcs microwave sensor tubes put into double tube batten, In close area not interfere each other
- ★ Sensor detection distance of 6-8 meter, Full lumen in activation mode, 30% lumen in standby mode
- ★ No interference from heat source and light source, high stability, long sensing distance
- ★ It has high sensitivity and no blind area. When there is an object moving, it will be sensed
- ★ Easy to install, strong hiding ability, can penetrate acrylic and other panels
- ★ 抗干擾設計,可以在雙支架下,近距離放二支微波燈管,而不相互干擾
- ★ 感測器探測距離6-8米,啟動模式下全流明,待機模式下30%流明
- ★ 不受熱源和光源干擾,穩定性高,感應距離遠
- ★ 感應靈敏度高,無盲區,有物體移動就會感應
- ★ 便於安裝,隱避性強,可穿透亞克力等面板

Specification 產品規格>>

Model 型號	Voltage 電壓 (V)	Wattage 功率 (W)	Length 長度 (mm)	Lamp Life 光度壽命 (Hrs)	Colour Temp 色溫 (K)	Lumen Output 輸出流明 (Lm/W)	Color Rendering 顯色度 (CRI)	Lamp Base 燈腳	PCS/CTN 每箱數量 (pcs)
LT-I0609-M108A-AI	100~240	9	600	30,000	3000/4000/6500	100	>80	T8,G13	25
LT-I0912-M108A-AI	100~240	12	900	30,000	3000/4000/6500	100	>80	T8,G13	25
LT-I1218-M108A-AI	100~240	18	1200	30,000	3000/4000/6500	100	>80	T8,G13	25
LT-I1522-M108A-AI	100~240	22	1500	30,000	3000/4000/6500	100	>80	T8,G13	25

Light efficiency (lm/W), Power (W), Color Rendering Index (CRI), Can be customized according to customer needs

Our Standard Power factor (PF) > 0.9 and Total harmonic index THD < 15%, According to customer requirements can produce a lower THD < 10%

This type of certification is issued by a government-approved laboratory for Safety certification, Fire testing, Restriction of Hazardous Substances (RoHS), Photobiological safety of lamps and lamp systems. (an Exemption Group) and other test certifications to ensure product quality

光效 (lm/W)、功率 (W)、顯色指數 (CRI), 可根據客戶需求定制

此型號標準之功率因素 (PF) > 0.9, 總諧波指數 THD < 15%, 可按客戶需要生產低總諧波指數 < 10%

此型號認證由可實驗室發出之安全認證消防測試, 環保物料 (RoHS), 光生物安全為 Exemption Group 及其它測試, 保證客戶使用更安心滿意



東權 LED 照明公司
EASTLIKE LED Co., Ltd

Office Address: Room B3, 18/F Bonsun Industrial Building, 364-366 Sha Tsui Road, Tsuen Wan, HongKong
Phone: 852-39745593 Fax: 852-35440462 info@eastlike.com www.eastlike.com

Radar Sensor LED Fluorescent Lamp

Series Type: ML

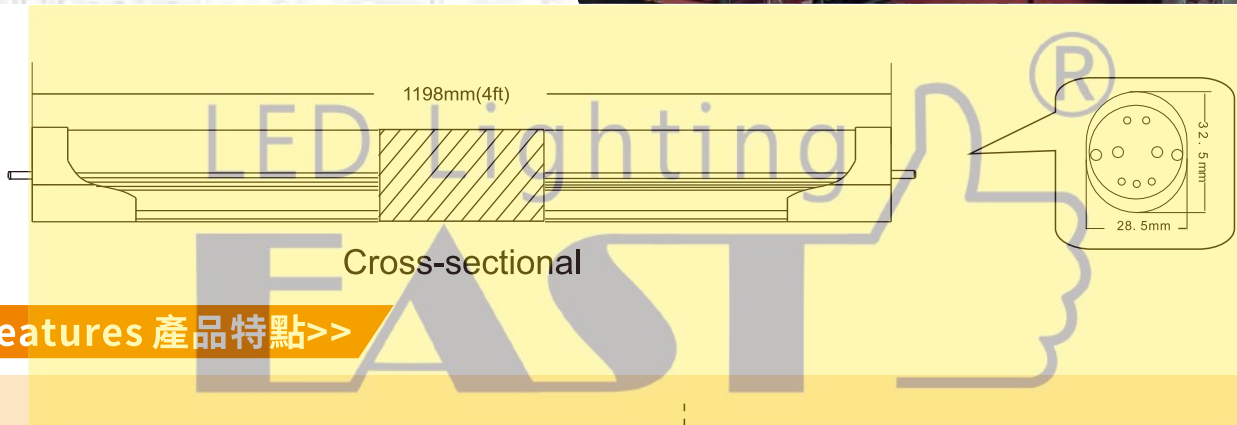

Features 產品特點>>

- ★ Car lights are on, intelligent delay, long-distance sensing
- ★ Objects that sense activity, are not affected by temperature and can pass through walls
- ★ Suitable for corridors, warehouses, parking lots

- ★ 車來燈亮, 智能延遲, 長距離感應
- ★ 感應活動的物體, 不受溫度影響, 能穿牆
- ★ 適用於走廊、倉庫、停車場

Specification 產品規格>>

Model 型號	Voltage 電壓	Wattage 功率	Length 長度	Lamp Life 光度壽命	Colour Temp 色溫	Sensing distance 感應距離	Luminous Flux 光通量	Color Rendering 顯色度
	(V)	(W)	(mm)	(Hrs)	(K)	(m)	(Lm)	(CRI)
LT-I1208-ML	185-265	8	1200	30,000	3000/4000/6000	4-8	1000-1300	80

Light efficiency (lm/W), Power (W), Color Rendering Index (CRI), Can be customized according to customer needs

Our Standard Power factor (PF) > 0.9 and Total harmonic index THD < 15%, According to customer requirements can produce a lower THD < 10%

This type of certification is issued by a government-approved laboratory for Safety certification, Fire testing, Restriction of Hazardous Substances (RoHS), Photobiological safety of lamps and lamp systems. (an Exemption Group) and other test certifications to ensure product quality

光效 (lm/W)、功率 (W)、顯色指數 (CRI), 可根據客戶需求定制

此型號標準之功率因素 (PF) > 0.9, 總諧波指數 THD < 15%, 可按客戶需要生產低總諧波指數 < 10%

此型號認證由可實驗室發出之安全認證消防測試, 環保物料 (RoHS), 光生物安全為 Exemption Group 及其它測試, 保證客戶使用更安心滿意



東樞 LED 照明公司
EASTLIKE LED Co., Ltd

Office Address: Room B3, 18/F Bonsun Industrial Building, 364-366 Sha Tsui Road, Tsuen Wan, HongKong
Phone: 852-39745593 Fax: 852-35440462 info@eastlike.com www.eastlike.com

Radar Sensor Sensor LED T8 Tube

Series Type: BL-M-P



Features 產品特點>>

- ★ Light control function: when the environment has light, it does not work at all; when the environment is not light, it enters the induction controlled state
- ★ Radar sensing function: In the absence of light, when there is a moving object, the radar will sense the action, enter the full negative state, power 4W, and delay 16-20 seconds; when no moving object triggers, the light will go
- ★ Sensing distance: 5-6 meters, 360 degree range under the lamp
- ★ Use range: especially suitable for residential corridors; and energy-saving automatic lighting places such as corridors, bathrooms, basements, garages, warehouses, and monitoring
- ★ 光控功能:當環境有光時完全不工作;當環境無光時進入感應受控狀態
- ★ 微波感應功能:在無光條件下,有移動物體時,微波感應動作進入滿負狀態,功率4W,並延遲16-20秒;無移動物體觸發時,燈滅
- ★ 感應距離:5-6米,燈下360度範圍
- ★ 使用範圍:特別適合小區樓道;以及走廊、衛生間、地下室、車庫、倉庫、監控等節能自動照明場所

Specification 產品規格>>

Model 型號	Voltage 電壓	Wattage 功率	Size 尺寸	Lamp Life 光度壽命	Colour Temp 色溫	Sensing distance 感應距離	Luminous Flux 光通量	Color Rendering 顯色度
	(V)	(W)	(mm)	(Hrs)	(K)	(m)	(Lm)	(CRI)
BL-M-P03	185-265	2.5	55	30,000	3000/4000/6000	5-6	180-260	80

Light efficiency (lm/W), Power (W), Color Rendering Index (CRI), Can be customized according to customer needs

Our Standard Power factor (PF) > 0.9 and Total harmonic index THD < 15%, According to customer requirements can produce a lower THD < 10%

This type of certification is issued by a government-approved laboratory for Safety certification, Fire testing, Restriction of Hazardous Substances (RoHS), Photobiological safety of lamps and lamp systems. (an Exemption Group) and other test certifications to ensure product quality

光效 (lm/W)、功率 (W)、顯色指數 (CRI), 可根據客戶需求定制

此型號標準之功率因素 (PF) > 0.9, 總諧波指數 THD < 15%, 可按客戶需要生產低總諧波指數 < 10%

此型號認證由可實驗室發出之安全認證消防測試, 環保物料 (RoHS), 光生物安全為 Exemption Group 及其它測試, 保證客戶使用更安心滿意



東權 LED 照明公司
EASTLIKE LED Co., Ltd

Office Address: Room B3, 18/F Bonsun Industrial Building, 364-366 Sha Tsui Road, Tsuen Wan, HongKong
Phone: 852-39745593 Fax: 852-35440462 info@eastlike.com www.eastlike.com

Radar Sensor LED Ceiling Light

Series Type: ILR-M



Features 產品特點>>

- ★ Radar sensing distance is longer, wide angle, no dead zone, can penetrate glass, and thin wood
- ★ Radar signals are transmitted on a plane 360°, integrated design, reduced overall size, save more space, more concise shape, more stable performance
- ★ Intelligent detection of the surrounding electromagnetic environment, no misjudgment due to climate or weather
- ★ Advanced radar sensing technology, high-efficiency LED light source, humanized technology, energy saving and environmental protection
- ★ Suitable for energy-saving matching corridors, garages, aisles, balconies, etc
- ★ 微波感應距離更遠, 角度廣, 無死區, 能穿透玻璃, 和薄木板
- ★ 平面360°發射微波信號, 一體化設計, 縮小整體尺寸, 節省更多空間, 造型更加簡潔, 性能更穩定
- ★ 智能檢測周圍電磁環境, 不會因氣候或天氣原因而導致誤判
- ★ 先進的微波感應技術, 高效能LED光源, 科技人性化, 節能環保
- ★ 適用於各種不同場所節能搭配樓道、車庫、過道、陽台等

Specification 產品規格>>

Model 型號	Voltage 電壓 (V)	Wattage 功率 (W)	Size 尺寸 (mm)	Lamp Life 光度壽命 (Hrs)	Colour Temp 色溫 (K)	Sensing distance 感應距離 (m)	Luminous Flux 光通量 (Lm)	Color Rendering 顯色度 (CRI)
ILR-M-3	185-265	2.5	190	30,000	3000/4000/6000	6-8	160-200	80
ILR-M-5	185-266	5	190	30,000	3000/4000/6000	6-8	300-350	80

Light efficiency (lm/W), Power (W), Color Rendering Index (CRI), Can be customized according to customer needs

Our Standard Power factor (PF) > 0.9 and Total harmonic index THD < 15%, According to customer requirements can produce a lower THD < 10%

This type of certification is issued by a government-approved laboratory for Safety certification, Fire testing, Restriction of Hazardous Substances (RoHS), Photobiological safety of lamps and lamp systems. (an Exemption Group) and other test certifications to ensure product quality

光效 (lm/W)、功率 (W)、顯色指數 (CRI), 可根據客戶需求定制

此型號標準之功率因素 (PF) > 0.9, 總諧波指數 THD < 15%, 可按客戶需要生產低總諧波指數 < 10%

此型號認證由可實驗室發出之安全認證消防測試, 環保物料 (RoHS), 光生物安全為 Exemption Group 及其它測試, 保證客戶使用更安心滿意



東樞 LED 照明公司
EASTLIKE LED Co., Ltd

Office Address: Room B3, 18/F Bonsun Industrial Building, 364-366 Sha Tsui Road, Tsuen Wan, HongKong
Phone: 852-39745593 Fax: 852-35440462 info@eastlike.com www.eastlike.com

Radar Sensor LED Downlight

Series Type: GY

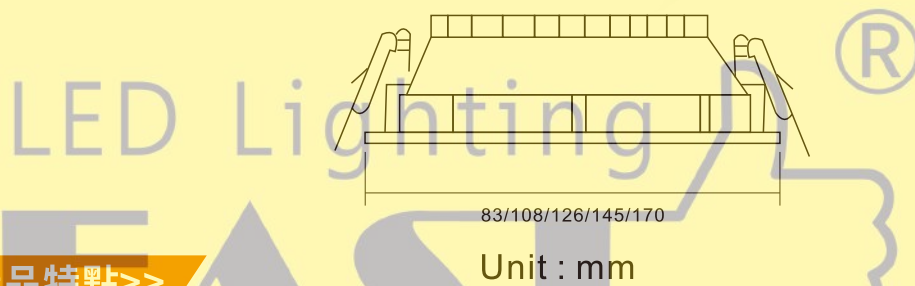

Features 產品特點>>

- ★ When people come, the lights are on, when people go, the lights are off, intelligent design, bid farewell to the dark, 360° no dead angle induction
- ★ According to the external light intensity, to control whether the switch is working or not, it has reached the energy-saving effect. And identify day and night
- ★ The switch will automatically extend a cycle after detecting each human activity, and start with the delay time of the last human activity
- ★ Mainly aimed at places with plaster or wood ceilings, used in aisles or community lobbies, with complete product specifications
- ★ 人來燈亮, 人走燈滅, 智能設計, 告別摸黑, 360°無死角感應
- ★ 根據外界的光線強度, 來控制開關是否工作, 已達到節能效能。並識別白天和黑夜
- ★ 開關在檢測到人體的每一次活動後會自動順延一個週期, 並以最後一次人體活動的順延時間為起始點
- ★ 主要針對石膏或木板吊頂的場所, 應用於過道或小區大堂, 產品規格齊全

Specification 產品規格>>

Model 型號	Voltage 電壓 (V)	Wattage 功率 (W)	Size 尺寸 (mm)	Lamp Life 光度壽命 (Hrs)	Colour Temp 色溫 (K)	Sensing distance 感應距離 (m)	Luminous Flux 光通量 (Lm)	Color Rendering 顯色度 (CRI)
DL-M-2.5GY	185-265	3	73-83	30000	3000/4000/6000	6-8	180-260	80
DL-M-3GY	185-265	4	96-108	30000	3000/4000/6000	6-8	300-350	80
DL-M-4GY	185-265	7	115-126	30000	3000/4000/6000	6-8	550-600	80
DL-M-5GY	185-265	10	137-145	30000	3000/4000/6000	6-8	800-850	80
DL-M-6GY	185-265	10	155-170	30000	3000/4000/6000	6-8	800-850	80

Light efficiency (lm/W), Power (W), Color Rendering Index (CRI), Can be customized according to customer needs

Our Standard Power factor (PF) > 0.9 and Total harmonic index THD < 15%, According to customer requirements can produce a lower THD < 10%

This type of certification is issued by a government-approved laboratory for Safety certification, Fire testing, Restriction of Hazardous Substances (RoHS), Photobiological safety of lamps and lamp systems. (an Exemption Group) and other test certifications to ensure product quality

光效 (lm/W)、功率 (W)、顯色指數 (CRI), 可根據客戶需求定制

此型號標準之功率因素 (PF) > 0.9, 總諧波指數 THD < 15%, 可按客戶需要生產低總諧波指數 < 10%

此型號認證由可實驗室發出之安全認證消防測試, 環保物料 (RoHS), 光生物安全為 Exemption Group 及其它測試, 保證客戶使用更安心滿意



東權 LED 照明公司
EASTLIKE LED Co., Ltd

Office Address: Room B3, 18/F Bonsun Industrial Building, 364-366 Sha Tsui Road, Tsuen Wan, HongKong
Phone: 852-39745593 Fax: 852-35440462 info@eastlike.com www.eastlike.com

Light Control And Time Control Bulb

Series Type: BL-MT-P

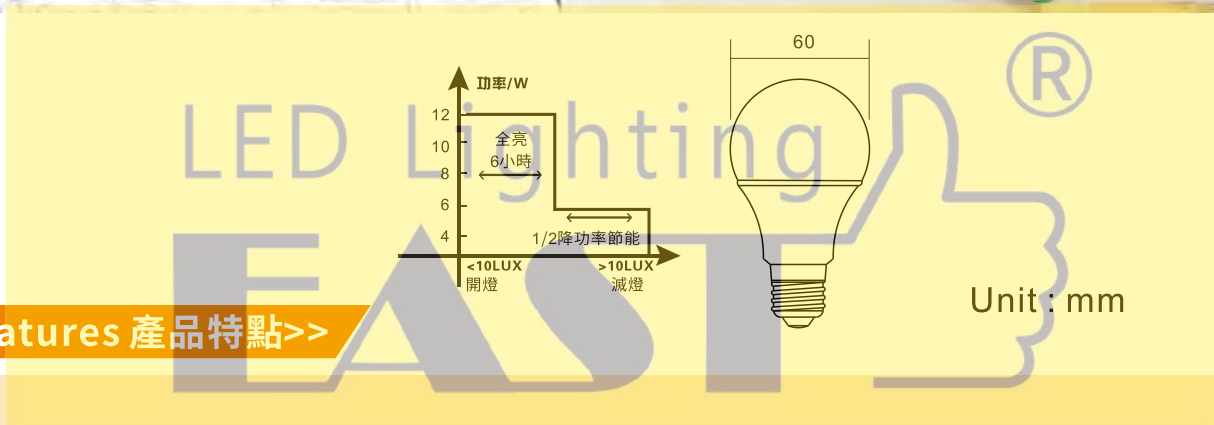

Features 產品特點>>

- ★ Stable light source, uniform light, no video flicker
- ★ Aluminum substrate light bar heat conduction, good circuit heat conduction, fast heat dissipation
- ★ Safe drive, provide stable power for the light source
- ★ Use international general lamp holder, anti-oxidation and anti-rust treatment

- ★ 光源穩定, 光線均勻, 無視頻閃
- ★ 鋁基板燈條導熱, 線路導熱良好、散熱快
- ★ 安全驅動, 為光源提供穩定的電源
- ★ 採用國際通用燈頭, 抗氧化防銹處理

Specification 產品規格>>

Model 型號	Voltage 電壓	Wattage 功率	Size 尺寸	Lamp Life 光度壽命	Colour Temp 色溫	Lighting Mode 亮燈模式	Luminous Flux 光通量	Color Rendering 顯色度
	(V)	(W)	(mm)	(Hrs)	(K)	(m)	(Lm)	(CRI)
BL-MT-P05	185-265	5	60	30000	3000/4000/6000	Light control + time control	400-600	80

Light efficiency (lm/W), Power (W), Color Rendering Index (CRI), Can be customized according to customer needs

Our Standard Power factor (PF) > 0.9 and Total harmonic index THD < 15%, According to customer requirements can produce a lower THD < 10%

This type of certification is issued by a government-approved laboratory for Safety certification, Fire testing, Restriction of Hazardous Substances (RoHS), Photobiological safety of lamps and lamp systems. (an Exemption Group) and other test certifications to ensure product quality

光效 (lm/W)、功率 (W)、顯色指數 (CRI), 可根據客戶需求定制

此型號標準之功率因素 (PF) > 0.9, 總諧波指數 THD < 15%, 可按客戶需要生產低總諧波指數 < 10%

此型號認證由可實驗室發出之安全認證消防測試, 環保物料 (RoHS), 光生物安全為 Exemption Group 及其它測試, 保證客戶使用更安心滿意



東樞 LED 照明公司
EASTLIKE LED Co., Ltd

Office Address: Room B3, 18/F Bonsun Industrial Building, 364-366 Sha Tsui Road, Tsuen Wan, HongKong
Phone: 852-39745593 Fax: 852-35440462 info@eastlike.com www.eastlike.com

Radar Sensor Moisture-proof Light

Series Type: BH-M-P



Features 產品特點>>

- ★ Mainly for bathrooms, cold storage and other places
- ★ Outdoor corridor, moisture-proof
- ★ Easy installation and lower transformation cost
- ★ 主要針對浴室、冷庫等場所
- ★ 室外迴廊、防潮
- ★ 安裝簡便, 改造成本更低

Specification 產品規格>>

Model 型號	Voltage 電壓 (V)	Wattage 功率 (W)	Size 尺寸 (mm)	Lamp Life 光度壽命 (Hrs)	Colour Temp 色溫 (K)	Sensing distance 感應距離 (m)	Luminous Flux 光通量 (Lm)	Color Rendering 顯色度 (CRI)
BH-M-P8	185-265	8	176	30,000	3000/4000/6000	6-8	850	80
BH-M-P12	185-265	12	176	30,000	3000/4000/6000	6-8	1100	80

Light efficiency (lm/W), Power (W), Color Rendering Index (CRI), Can be customized according to customer needs

Our Standard Power factor (PF) > 0.9 and Total harmonic index THD < 15%, According to customer requirements can produce a lower THD < 10%

This type of certification is issued by a government-approved laboratory for Safety certification, Fire testing, Restriction of Hazardous Substances (RoHS), Photobiological safety of lamps and lamp systems. (an Exemption Group) and other test certifications to ensure product quality

光效 (lm/W)、功率 (W)、顯色指數 (CRI), 可根據客戶需求定制

此型號標準之功率因素 (PF) > 0.9, 總諧波指數 THD < 15%, 可按客戶需要生產低總諧波指數 < 10%

此型號認證由可實驗室發出之安全認證消防測試, 環保物料 (RoHS), 光生物安全為 Exemption Group 及其它測試, 保證客戶使用更安心滿意



東權 LED 照明公司
EASTLIKE LED Co., Ltd

Office Address: Room B3, 18/F Bonsun Industrial Building, 364-366 Sha Tsui Road, Tsuen Wan, HongKong
Phone: 852-39745593 Fax: 852-35440462 info@eastlike.com www.eastlike.com

UVC Induction Germicidal Lamp British Batten

Series Type: AS-M

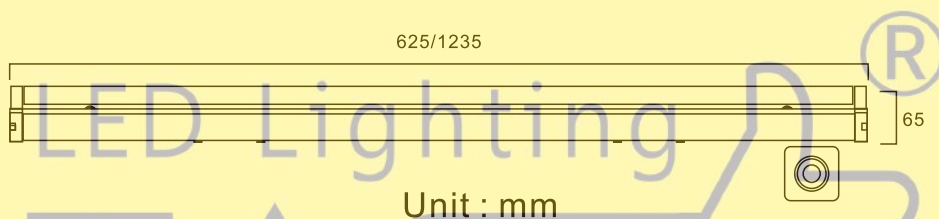
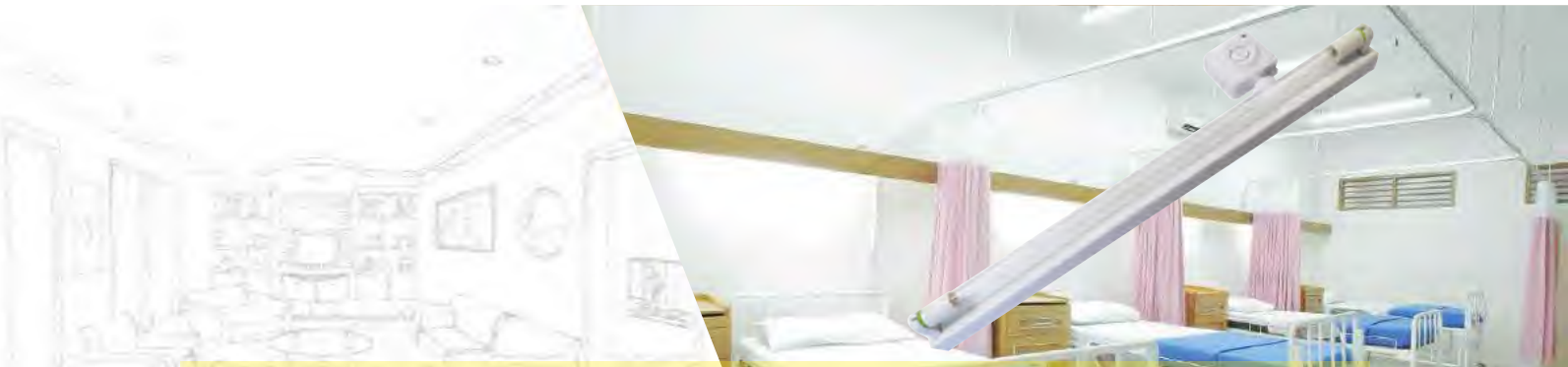

Features 產品特點>>

- ★ The product integrates ultraviolet UVC sterilization technology and microwave induction technology.
- ★ UVC ultraviolet rays directly destroy the DNA and RNA in bacterial virus cells, causing them to lose their ability to reproduce and cause the cells to die directly, thereby achieving the purpose of sterilization
- ★ Use special sensor for disinfection lamp: The sensor emits high frequency electromagnetic wave (5.8GHz), and the signal has strong penetration
- ★ During the anti-virus process, people come to suspend the disinfection, and after the person leaves, they will delay the antivirus
- ★ Suitable for homes, factories, hospitals, and other places that need to be disinfected
- ★ Timing control
- ★ 產品集紫外線UVC殺菌技術,微波感應技術與一體
- ★ UVC紫外線通過直接破壞細菌病毒細胞中的DNA, RNA, 恢復喪失繁殖能力致細胞直接死亡,從而達到殺菌的目的
- ★ 採用消毒燈專用感應器:感應器發射高頻電磁波(5.8GHz),信號穿透性強
- ★ 殺毒過程中,人來暫停消毒,人走後自行重啟殺毒
- ★ 適用於家庭,工廠,醫院,等需要消毒殺菌的場所
- ★ 可定時控制

Specification 產品規格>>

Model 型號	Voltage 電壓 (V)	Wattage 功率 (W)	Wavelength 波長 (nm)	Lamp Base 燈腳	Lamp Life 光度壽命 (Hrs)	Size 尺寸 (mm)
AS-M0620	220-240	20	253.7	T8, G13	30,000	23*589
AS-M1240	220-240	40	253.7	T8, G13	30,000	23*1200

Light efficiency (lm/W), Power (W), Color Rendering Index (CRI), Can be customized according to customer needs

Our Standard Power factor (PF) > 0.9 and Total harmonic index THD < 15%, According to customer requirements can produce a lower THD < 10%

This type of certification is issued by a government-approved laboratory for Safety certification, Fire testing, Restriction of Hazardous Substances (RoHS), Photobiological safety of lamps and lamp systems. (an Exemption Group) and other test certifications to ensure product quality

光效 (lm/W)、功率 (W)、顯色指數 (CRI), 可根據客戶需求定制

此型號標準之功率因素 (PF) > 0.9, 總諧波指數 THD < 15%, 可按客戶需要生產低總諧波指數 < 10%

此型號認證由可實驗室發出之安全認證消防測試, 環保物料 (RoHS), 光生物安全為 Exemption Group 及其它測試, 保證客戶使用更安心滿意



東攏 LED 照明公司
EASTLIKE LED Co., Ltd

Office Address: Room B3, 18/F Bonsun Industrial Building, 364-366 Sha Tsui Road, Tsuen Wan, HongKong
Phone: 852-39745593 Fax: 852-35440462 info@eastlike.com www.eastlike.com



LED Lighting Integrated Application

綜合應用系列



東權LED照明公司
EASTLIKE LED Co., Ltd

Office Address: Room B3, 18/F Bonsun Industrial Building, 364-366 Sha Tsui Road, Tsuen Wan, HongKong
Phone: 852-39745593 Fax: 852-35440462 info@eastlike.com www.eastlike.com

LED Bulb

Series Type: BL-A-H



LED Lighting

EAST

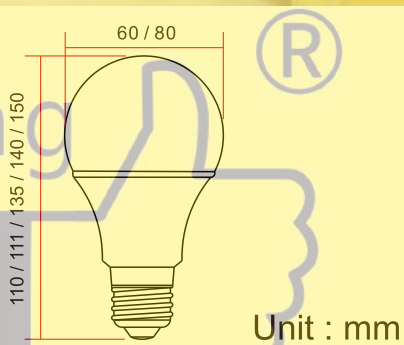

Features 產品特點>>

- | | |
|--------------------------------------------------------------------------------------------------------------------------------------------------------------------------------------------------------------------------------------------------------------------------------------------------------------------------------------------------------------------------------------------------------------------------------------------------------------------------------|------------------------------------------------------------------------------------------------------------------------------------------------------------------------------------------------------|
| <ul style="list-style-type: none"> ★ A++ energy certification, environmental protection and energy saving ★ E27 screw head lamp foot ★ Even light emission, no video flicker, no ultraviolet and infrared. ★ High luminous output and low power consumption ★ Does not contain mercury or other harmful substances ★ SPM design-power circuit protection function can cut off a single LED in the event of a fault | <ul style="list-style-type: none"> ★ A++能源認證,環保慳電 ★ E27螺頭燈腳 ★ 發光均勻,無可視頻閃,無紫外線和紅外線。 ★ 高發光輸出和低功耗 ★ 不含汞或其他有害物質 ★ SPM設計-電源電路保護功能可在故障時切斷單個LED |
|--------------------------------------------------------------------------------------------------------------------------------------------------------------------------------------------------------------------------------------------------------------------------------------------------------------------------------------------------------------------------------------------------------------------------------------------------------------------------------|------------------------------------------------------------------------------------------------------------------------------------------------------------------------------------------------------|

Specification 產品規格>>

Model 型號	Voltage 電壓	Wattage 功率	Size 尺寸	Lamp Life 光度壽命	Colour Temp 色溫	Lumen Output 輸出流明	Color Rendering 顯色度	Beam Angle 光速角度	Operating Temperature 工作溫度
	(V)	(W)	(mm)	(Hrs)	(K)	(Lm/W)	(CRI)	(°)	(°C)
BL-A06-H158A	85~265	6	Ø60*111	30,000	3000/4000/6500	150	>80	180	-20~+45
BL-A08-H108A	85~265	8	Ø80*135	30,000	3000/4000/6500	150	>80	180	-20~+45

Light efficiency (lm/W), Power (W) Can be customized according to customer needs

This type of certification is issued by a government-approved laboratory for Safety certification, Fire testing, Restriction of Hazardous Substances (RoHS), Photobiological safety of lamps and lamp systems. (an Exemption Group) and other test certifications to ensure product quality

光效 (lm/W)、功率 (W) 可根據客戶需求定制

此型號認證由可實驗室發出之安全認證消防測試, 環保物料 (RoHS), 光生物安全為 Exemption Group 及其它測試, 保證客戶使用更安心滿意



東樞LED照明公司
EASTLIKE LED Co., Ltd

Office Address: Room B3, 18/F Bonsun Industrial Building, 364-366 Sha Tsui Road, Tsuen Wan, HongKong
Phone: 852-39745593 Fax: 852-35440462 info@eastlike.com www.eastlike.com

Hing Power LED Bulb

Series Type:BL-A-E27

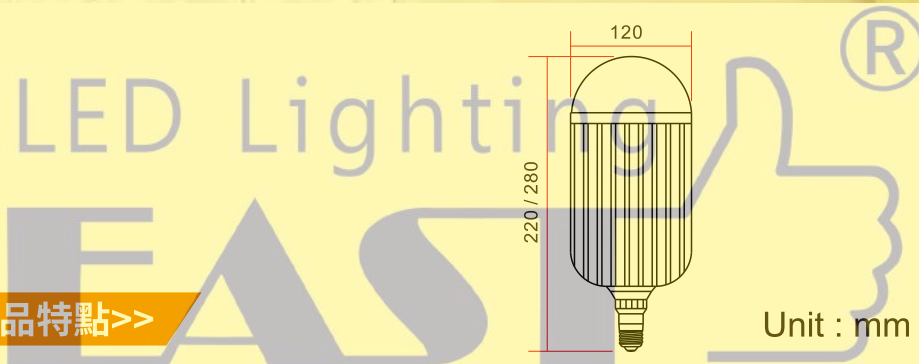

Features 產品特點>>

- ★ E27 screw head lamp foot
 - ★ Even light emission, no video flicker, no ultraviolet and infrared
 - ★ High luminous output and low power consumption
 - ★ Does not contain mercury or other harmful substances
 - ★ SPM design-power circuit protection function can cut off a single LED in the event of a fault
- ★ E27螺頭燈腳
 - ★ 發光均勻,無可視頻閃,無紫外線和紅外線
 - ★ 高發光輸出和低功耗
 - ★ 不含汞或其他有害物質
 - ★ SPM設計-電源電路保護功能可在故障時切斷單個LED

Specification 產品規格>>

Model 型號	Voltage 電壓	Wattage 功率	Size 尺寸	Lamp Life 光度壽命	Colour Temp 色溫	Lumen Output 輸出流明	Color Rendering 顯色度	Beam Angle 光速角度	Operating Temperature 工作溫度
	(V)	(W)	(mm)	(Hrs)	(K)	(Lm/W)	(CRI)	(°)	(°C)
BL-A30-H108-E27	85~265	30	Ø120*220	30,000	3000/4000/6500	150	>80	180	-20~+45
BL-A50-H108-E27	85~265	50	Ø120*280	30,000	3000/4000/6500	150	>80	180	-20~+45

Light efficiency (lm/W), Power (W) can be customized according to customer needs

This type of certification is issued by a government-approved laboratory for Safety certification, Fire testing, Restriction of Hazardous Substances (RoHS), Photobiological safety of lamps and lamp systems. (an Exemption Group) and other test certifications to ensure product quality

光效 (lm/W)、功率 (W) 可根據客戶需求定制

此型號認證由可實驗室發出之安全認證消防測試, 環保物料 (RoHS), 光生物安全為 Exemption Group 及其它測試, 保證客戶使用更安心滿意



東樞LED照明公司
EASTLIKE LED Co., Ltd

Office Address: Room B3, 18/F Bonsun Industrial Building, 364-366 Sha Tsui Road, Tsuen Wan, HongKong
Phone: 852-39745593 Fax: 852-35440462 info@eastlike.com www.eastlike.com

Hing Power LED Bulb

Series Type: BL-A-E40

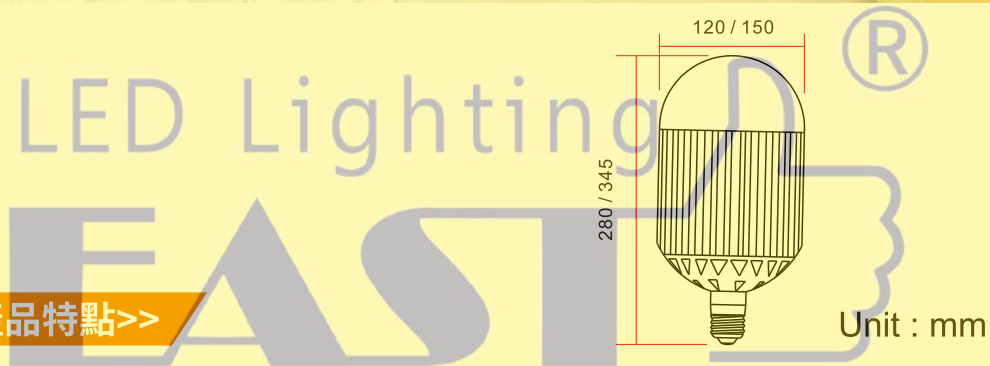

Features 產品特點>>

- ★ E40 screw head lamp foot
 - ★ Even light emission, no video flicker, no ultraviolet and infrared
 - ★ High luminous output and low power consumption
 - ★ Does not contain mercury or other harmful substances
 - ★ SPM design-power circuit protection function can cut off a single LED in the event of a fault
- ★ E40螺頭燈腳
 - ★ 發光均勻，無可視頻閃，無紫外線和紅外線
 - ★ 高發光輸出和低功耗
 - ★ 不含汞或其他有害物質
 - ★ SPM設計-電源電路保護功能可在故障時切斷單個LED

Specification 產品規格>>

Model 型號	Voltage 電壓	Wattage 功率	Size 尺寸	Lamp Life 光度壽命	Colour Temp 色溫	Lumen Output 輸出流明	Color Rendering 顯色度	Beam Angle 光速角度	Operating Temperature 工作溫度
	(V)	(W)	(mm)	(Hrs)	(K)	(Lm/W)	(CRI)	(°)	(°C)
BL-A50-H108-E40	85~265	50	Ø120*280	30,000	3000/4000/6500	100	>80	180	-20~+45
BL-A70-H108-E40	85~265	70	Ø150*345	30,000	3000/4000/6500	100	>80	180	-20~+45
BL-A100-H108-E40	85~265	100	Ø150*345	30,000	3000/4000/6500	100	>80	180	-20~+45

Light efficiency (lm/W), Power (W) Can be customized according to customer needs

This type of certification is issued by a government-approved laboratory for Safety certification, Fire testing, Restriction of Hazardous Substances (RoHS), Photobiological safety of lamps and lamp systems. (an Exemption Group) and other test certifications to ensure product quality

光效 (lm/W)、功率 (W) 可根據客戶需求定制

此型號認證由可實驗室發出之安全認證消防測試，環保物料 (RoHS)，光生物安全為 Exemption Group 及其它測試，保證客戶使用更安心滿意



東攏LED照明公司
EASTLIKE LED Co., Ltd

Office Address: Room B3, 18/F Bonsun Industrial Building, 364-366 Sha Tsui Road, Tsuen Wan, HongKong
Phone: 852-39745593 Fax: 852-35440462 info@eastlike.com www.eastlike.com

LED Spotlight

Series Type:IMR-A-N

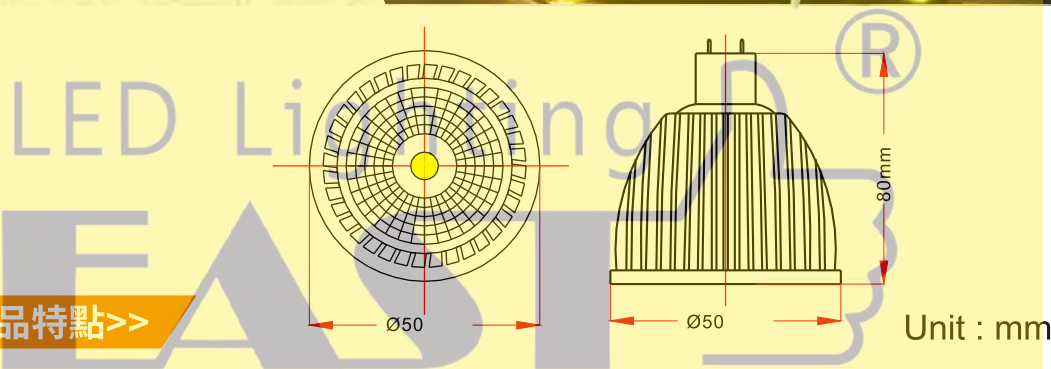

Features 產品特點>>

- ★ Using high-quality LED chips, low heat generation, stable performance, safe eye protection
- ★ Glass mask, strong light transmission, uniform light, strong refraction, large heat dissipation area
- ★ Three-dimensional cylindrical design, beautiful and unique appearance, long life
- ★ Suitable for hotels, shopping malls, offices, aisles, etc

- ★ 採用優質LED, 發熱量低, 性能穩定, 安全護眼
- ★ 玻璃面罩, 透光性強, 光線均勻, 折射性強, 散熱
- ★ 面積大立體圓柱設計, 外觀精美別致, 壽命長
- ★ 適用於飯店、商場、辦公室、過道等

Specification 產品規格>>

Model 型號	Voltage 電壓	Wattage 功率	Size 尺寸	Lamp Life 光度壽命	Colour Temp 色溫	Lumen Output 輸出流明	Color Rendering 顯色度	Beam Angle 光束角度	Operating Temperature 工作溫度
	(V)	(W)	(mm)	(Hrs)	(K)	(Lm/W)	(CRI)	(°)	(°C)
IMR16-A07-N108E	12	7	Ø50*80	30,000	3000/4000/6500	100	>80	60	-20~+45

Light efficiency (lm/W), Power (W) Can be customized according to customer needs

This type of certification is issued by a government-approved laboratory for Safety certification, Fire testing, Restriction of Hazardous Substances (RoHS), Photobiological safety of lamps and lamp systems. (an Exemption Group) and other test certifications to ensure product quality

光效 (lm/W)、功率 (W) 可根據客戶需求定制

此型號認證由可實驗室發出之安全認證消防測試, 環保物料 (RoHS), 光生物安全為 Exemption Group 及其它測試, 保證客戶使用更安心滿意



東樞LED照明公司
EASTLIKE LED Co., Ltd

Office Address: Room B3, 18/F Bonsun Industrial Building, 364-366 Sha Tsui Road, Tsuen Wan, HongKong
Phone: 852-39745593 Fax: 852-35440462 info@eastlike.com www.eastlike.com

LED Spotlight

Series Type:IMR-B-H

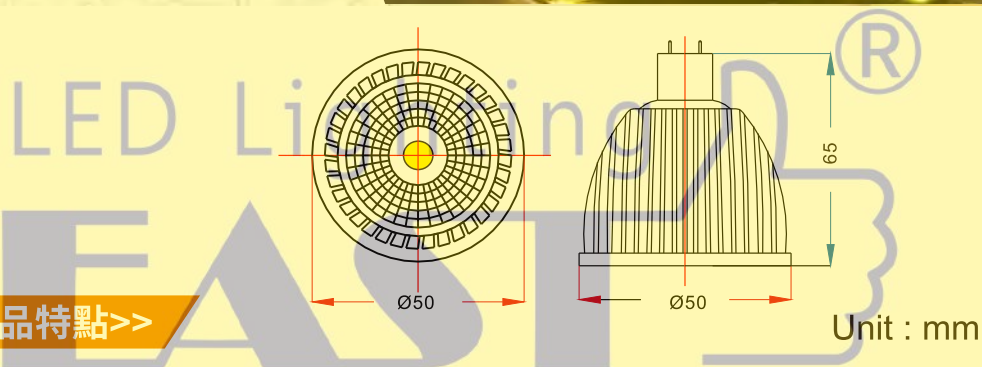

Features 產品特點>>

- ★ Using high-quality LED chips, low heat generation, stable performance, safe eye protection
- ★ Glass mask, strong light transmission, uniform light, strong refraction, large heat dissipation area
- ★ Three-dimensional cylindrical design, beautiful and unique appearance, long life
- ★ Suitable for hotels, shopping malls, offices, aisles, etc

- ★ 採用優質LED,發熱量低,性能穩定,安全護眼
- ★ 玻璃面罩,透光性強,光線均勻,折射性強,散熱面積大
- ★ 立體圓柱設計,外觀精美別致,壽命長
- ★ 適用於飯店、商場、辦公室、過道等

Specification 產品規格>>

Model 型號	Voltage 電壓	Wattage 功率	Size 尺寸	Lamp Life 光度壽命	Colour Temp 色溫	Lumen Output 輸出流明	Color Rendering 顯色度	Beam Angle 光速角度	Operating Temperature 工作溫度
	(V)	(W)	(mm)	(Hrs)	(K)	(Lm/W)	(CRI)	(°)	(°C)
IMR16-B05-H108E	12	5	Ø50*65	30,000	3000/4000/6500	100	>80	60	-20~+45

Light efficiency (lm/W), Power (W) Can be customized according to customer needs

This type of certification is issued by a government-approved laboratory for Safety certification, Fire testing, Restriction of Hazardous Substances (RoHS), Photobiological safety of lamps and lamp systems. (an Exemption Group) and other test certifications to ensure product quality

光效 (lm/W)、功率 (W) 可根據客戶需求定制

此型號認證由可實驗室發出之安全認證消防測試, 環保物料 (RoHS), 光生物安全為 Exemption Group 及其它測試, 保證客戶使用更安心滿意



東樞LED照明公司
EASTLIKE LED Co., Ltd

Office Address: Room B3, 18/F Bonsun Industrial Building, 364-366 Sha Tsui Road, Tsuen Wan, HongKong
Phone: 852-39745593 Fax: 852-35440462 info@eastlike.com www.eastlike.com

PAR Lamp

Series Type: PAR20-B

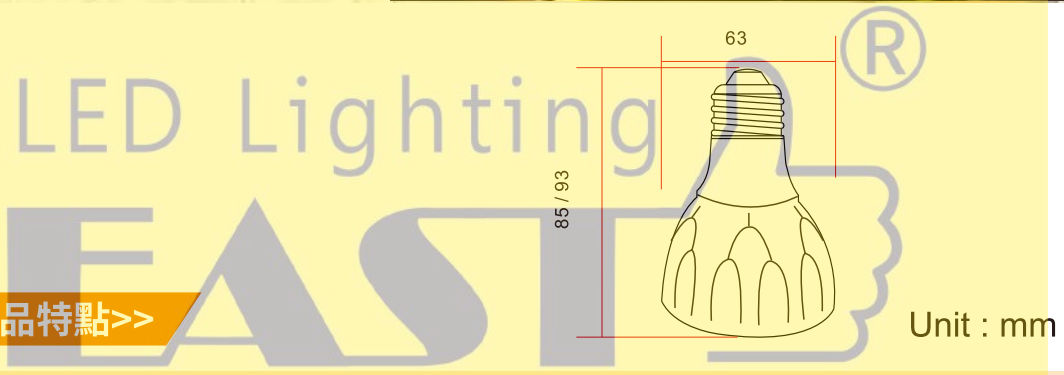

Features 產品特點>>

- ★ Energy saving and environmental protection, low energy consumption, high light efficiency, high heat dissipation, no flicker
- ★ Long life, low light decay, oxidation resistance, no fading
- ★ High power lumens LED
- ★ Suitable for offices, large supermarkets, stores, gyms, factory workshops, exhibition halls, stadiums, etc.
- ★ 節能環保、低耗能、高光效、高散熱、無頻閃
- ★ 超長壽命、低光衰、耐氧化、不褪色
- ★ 使用大功率高流明LED
- ★ 適用於辦公場所、大型超市、賣場、健身房、工廠車間、展廳、體育場等

Specification 產品規格>>

Model 型號	Voltage 電壓 (V)	Wattage 功率 (W)	Size 尺寸 (mm)	Lamp Life 光度壽命 (Hrs)	Colour Temp 色溫 (K)	Lumen Output 輸出流明 (Lm/W)	Color Rendering 顯色度 (CRI)	Beam Angle 光速角度 (°)	Operating Temperature 工作溫度 (°C)
IL-COB-PAR20-12W-B	85-265	12	Ø63*85	50000	3000/4000/6500	100	>80	15 / 24 / 36	-20~+45
IL-COB-PAR20-16W-B	85-265	16	Ø63*93	50000	3000/4000/6500	100	>80	15 / 24 / 36	-20~+45

Light efficiency (lm/W), Power (W) can be customized according to customer needs

This type of certification is issued by a government-approved laboratory for Safety certification, Fire testing, Restriction of Hazardous Substances (RoHS), Photobiological safety of lamps and lamp systems. (an Exemption Group) and other test certifications to ensure product quality

光效 (lm/W)、功率 (W) 可根據客戶需求定制

此型號認證由可實驗室發出之安全認證消防測試, 環保物料 (RoHS), 光生物安全為 Exemption Group 及其它測試, 保證客戶使用更安心滿意



東樞LED照明公司
EASTLIKE LED Co., Ltd

Office Address: Room B3, 18/F Bonsun Industrial Building, 364-366 Sha Tsui Road, Tsuen Wan, HongKong
Phone: 852-39745593 Fax: 852-35440462 info@eastlike.com www.eastlike.com

PAR Lamp

Series Type: PAR30-B

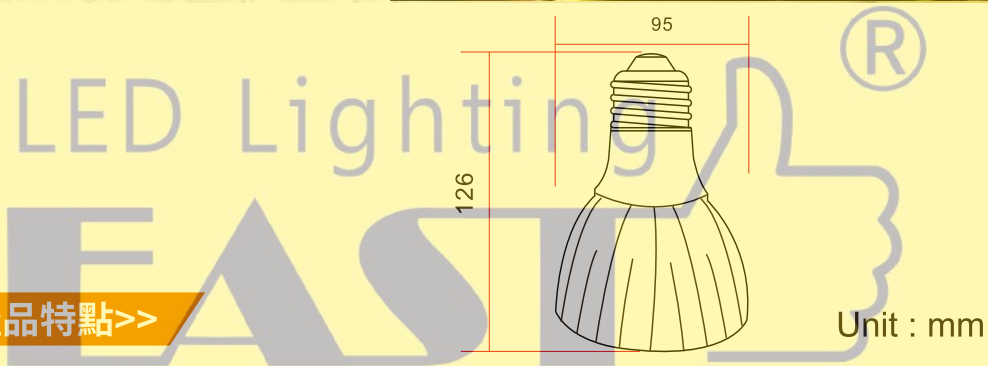

Features 產品特點>>

- ★ Energy saving and environmental protection, low energy consumption, high light efficiency, high heat dissipation, no flicker
- ★ Long life, low light decay, oxidation resistance, no fading
- ★ High power lumens LED
- ★ Suitable for offices, large supermarkets, stores, gyms, factory workshops, exhibition halls, stadiums, etc.

- ★ 節能環保、低耗能、高光效、高散熱、無頻閃
- ★ 超長壽命、低光衰、耐氧化、不褪色
- ★ 使用大功率高流明LED
- ★ 適用於辦公場所、大型超市、賣場、健身房、工廠車間、展廳、體育場等

Unit : mm

Specification 產品規格>>

Model 型號	Voltage 電壓	Wattage 功率	Size 尺寸	Lamp Life 光度壽命	Colour Temp 色溫	Lumen Output 輸出流明	Color Rendering 顯色度	Beam Angle 光速角度	Operating Temperature 工作溫度
	(V)	(W)	(mm)	(Hrs)	(K)	(Lm/W)	(CRI)	(°)	(°C)
IL-COB-PAR30-40W-B	85-265	40	Ø95*126	30,000	3000/4000/6500	100	>80	15 / 24 / 36	-20~+45

Light efficiency (lm/W), Power (W) Can be customized according to customer needs

This type of certification is issued by a government-approved laboratory for Safety certification, Fire testing, Restriction of Hazardous Substances (RoHS), Photobiological safety of lamps and lamp systems. (an Exemption Group) and other test certifications to ensure product quality

光效 (lm/W)、功率 (W) 可根據客戶需求定制

此型號認證由可實驗室發出之安全認證消防測試, 環保物料 (RoHS), 光生物安全為 Exemption Group 及其它測試, 保證客戶使用更安心滿意



東樞LED照明公司
EASTLIKE LED Co., Ltd

Office Address: Room B3, 18/F Bonsun Industrial Building, 364-366 Sha Tsui Road, Tsuen Wan, HongKong
Phone: 852-39745593 Fax: 852-35440462 info@eastlike.com www.eastlike.com

Ground Light

Series Type:GB-H108E-NF

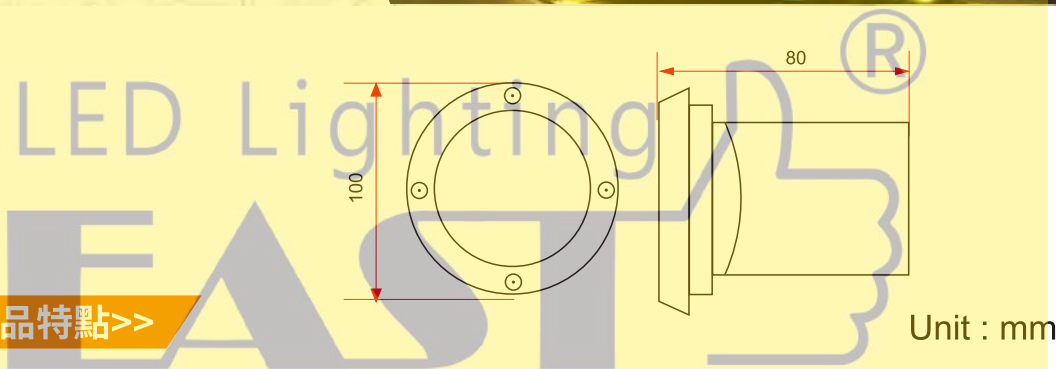

Features 產品特點>>

- ★ The LED ground light is ideal for both domestic and commercial applications
- ★ The protection grade is IP67, waterproof and dust proof, safe to use
- ★ Stable performance with built-in constant current driver,
- ★ Made by stainless steel and aluminum, the lamp can be protected perfectly
- ★ It's perfect for outdoor lighting such as landscape, garden, path, yard, etc
- ★ LED地面燈是家庭和商業應用的理想選擇
- ★ 防護等級為IP67, 防水防塵, 使用安全
- ★ 內置恆定電流驅動器, 性能穩定
- ★ 燈由不銹鋼和鋁製成, 可以得到完美的保護
- ★ 非常適合戶外照明, 例如景觀, 花園, 道路, 院子等

Specification 產品規格>>

Model 型號	Voltage 電壓	Wattage 功率	Size 尺寸	Lamp Life 光度壽命	Colour Temp 色溫	Lumen Output 輸出流明	Color Rendering 顯色度	Beam Angle 光速角度	Operating Temperature 工作溫度
	(V)	(W)	(mm)	(Hrs)	(K)	(Lm/W)	(CRI)	(°)	(°C)
GB-0303-H108E-NF	85-265	3	Ø100*80	30,000	3000/4000/6500	100	>80	30	-20~+45

Light efficiency (lm/W), Power (W) Can be customized according to customer needs

This type of certification is issued by a government-approved laboratory for Safety certification, Fire testing, Restriction of Hazardous Substances (RoHS), Photobiological safety of lamps and lamp systems. (an Exemption Group) and other test certifications to ensure product quality

光效 (lm/W)、功率 (W) 可根據客戶需求定制

此型號認證由可實驗室發出之安全認證消防測試, 環保物料 (RoHS), 光生物安全為 Exemption Group 及其它測試, 保證客戶使用更安心滿意



東樞LED照明公司
EASTLIKE LED Co., Ltd

Office Address: Room B3, 18/F Bonsun Industrial Building, 364-366 Sha Tsui Road, Tsuen Wan, HongKong
Phone: 852-39745593 Fax: 852-35440462 info@eastlike.com www.eastlike.com

Ground Light

Series Type:GB-H108A-NF

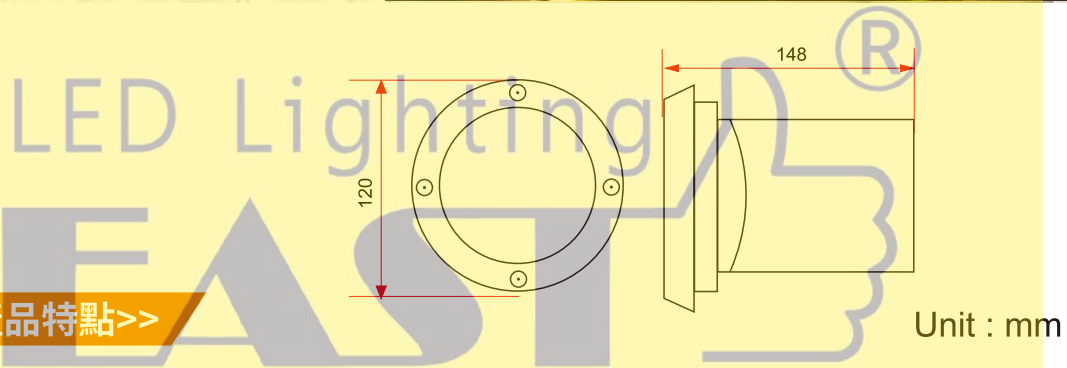

Features 產品特點>>

- ★ The LED ground light is ideal for both domestic and commercial applications
 - ★ The protection grade is IP67, waterproof and dust proof, safe to use
 - ★ Stable performance with built-in constant current driver,
 - ★ Made by stainless steel and aluminum, the lamp can be protected perfectly
 - ★ It's perfect for outdoor lighting such as landscape, garden, path, yard, etc
- ★ LED地面燈是家庭和商業應用的理想選擇
 - ★ 防護等級為IP67, 防水防塵, 使用安全
 - ★ 內置恆定電流驅動器, 性能穩定
 - ★ 燈由不銹鋼和鋁製成, 可以得到完美的保護
 - ★ 非常適合戶外照明, 例如景觀, 花園, 道路, 院子等

Specification 產品規格>>

Model 型號	Voltage 電壓	Wattage 功率	Size 尺寸	Lamp Life 光度壽命	Colour Temp 色溫	Lumen Output 輸出流明	Color Rendering 顯色度	Beam Angle 光速角度	Operating Temperature 工作溫度
	(V)	(W)	(mm)	(Hrs)	(K)	(Lm/W)	(CRI)	(°)	(°C)
GB-0303-H108A-NF	85-265	3	Ø120*148	30,000	3000/4000/6500	100	>80	30	-20~+45

Light efficiency (lm/W), Power (W) Can be customized according to customer needs

This type of certification is issued by a government-approved laboratory for Safety certification, Fire testing, Restriction of Hazardous Substances (RoHS), Photobiological safety of lamps and lamp systems. (an Exemption Group) and other test certifications to ensure product quality

光效 (lm/W)、功率 (W) 可根據客戶需求定制

此型號認證由可實驗室發出之安全認證消防測試, 環保物料 (RoHS), 光生物安全為 Exemption Group 及其它測試, 保證客戶使用更安心滿意



東樞LED照明公司
EASTLIKE LED Co., Ltd

Office Address: Room B3, 18/F Bonsun Industrial Building, 364-366 Sha Tsui Road, Tsuen Wan, HongKong
Phone: 852-39745593 Fax: 852-35440462 info@eastlike.com www.eastlike.com

Under Water Light

Series Type:IPUW-2324

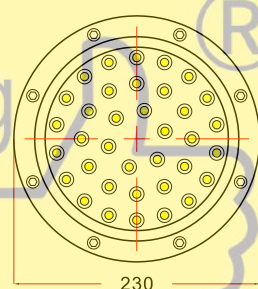
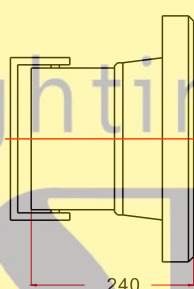

Unit : mm

Features 產品特點>>

- ★ The LED ground light is ideal for both domestic and commercial applications
- ★ The protection grade is IP68, waterproof and dust proof, safe to use
- ★ Stable performance with built-in constant current driver
- ★ Made by stainless steel and aluminum, the lamp can be protected perfectly
- ★ It's perfect for outdoor lighting such as landscape, garden, path, yard, etc
- ★ LED地面燈是家庭和商業應用的理想選擇
- ★ 防護等級為IP68, 防水防塵, 使用安全
- ★ 內置恆定電流驅動器, 性能穩定
- ★ 燈由不銹鋼和鋁製成, 可以得到完美的保護
- ★ 非常適合戶外照明, 例如景觀, 花園, 道路, 院子等

Specification 產品規格>>

Model 型號	Voltage 電壓	Wattage 功率	Size 尺寸	Lamp Life 光度壽命	Colour Temp 色溫	Lumen Output 輸出流明	Color Rendering 顯色度	Beam Angle 光速角度	Operating Temperature 工作溫度
	(V)	(W)	(mm)	(Hrs)	(K)	(Lm/W)	(CRI)	(°)	(°C)
IPUW-232436-H118A	85-265	36	Ø230*240	30,000	3000/4000/6500	110	>80	90	-20~+45

Light efficiency (lm/W), Power (W) Can be customized according to customer needs

This type of certification is issued by a government-approved laboratory for Safety certification, Fire testing, Restriction of Hazardous Substances (RoHS), Photobiological safety of lamps and lamp systems. (an Exemption Group) and other test certifications to ensure product quality

光效 (lm/W)、功率 (W) 可根據客戶需求定制

此型號認證由可實驗室發出之安全認證消防測試, 環保物料 (RoHS), 光生物安全為 Exemption Group 及其它測試, 保證客戶使用更安心滿意



東樞LED照明公司
EASTLIKE LED Co., Ltd

Office Address: Room B3, 18/F Bonsun Industrial Building, 364-366 Sha Tsui Road, Tsuen Wan, HongKong
Phone: 852-39745593 Fax: 852-35440462 info@eastlike.com www.eastlike.com

Wall Pack Light

Series Type:WL-P15



LED Lighting

EAST

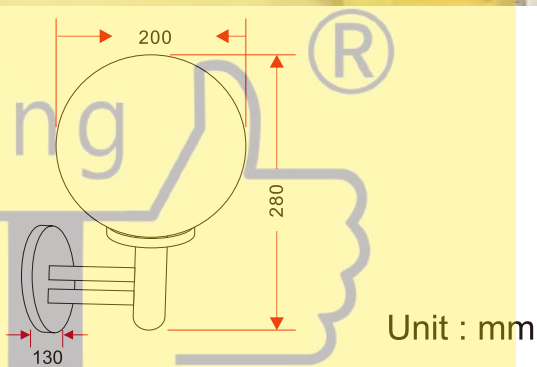

Unit : mm

Features 產品特點>>

- ★ The LED ground light is ideal for both domestic and commercial applications
 - ★ The protection grade is IP67, waterproof and dust proof, safe to use
 - ★ Stable performance with built-in constant current driver,
 - ★ Made by stainless steel and aluminum, the lamp can be protected perfectly
 - ★ It's perfect for outdoor lighting such as landscape, garden, path, yard, etc
- ★ LED地面燈是家庭和商業應用的理想選擇
 - ★ 防護等級為IP67, 防水防塵, 使用安全
 - ★ 內置恆定電流驅動器, 性能穩定
 - ★ 燈由不銹鋼和鋁製成, 可以得到完美的保護
 - ★ 非常適合戶外照明, 例如景觀, 花園, 道路, 院子等

Specification 產品規格>>

Model 型號	Voltage 電壓	Wattage 功率	Size 尺寸	Lamp Life 光度壽命 (Hrs)	Colour Temp 色溫 (K)	Lumen Output 輸出流明 (Lm/W)	Color Rendering 顯色度 (CRI)	Beam Angle 光速角度 (°)	Operating Temperature 工作溫度 (°C)
WL-P15-H108A	110~240	15	Ø200*280	30,000	3000/4000/6500	100	>80	300	-20~+45

Light efficiency (lm/W), Power (W) Can be customized according to customer needs

This type of certification is issued by a government-approved laboratory for Safety certification, Fire testing, Restriction of Hazardous Substances (RoHS), Photobiological safety of lamps and lamp systems. (an Exemption Group) and other test certifications to ensure product quality

光效 (lm/W)、功率 (W) 可根據客戶需求定制

此型號認證由可實驗室發出之安全認證消防測試, 環保物料 (RoHS), 光生物安全為 Exemption Group 及其它測試, 保證客戶使用更安心滿意



東樞LED照明公司
EASTLIKE LED Co., Ltd

Office Address: Room B3, 18/F Bonsun Industrial Building, 364-366 Sha Tsui Road, Tsuen Wan, HongKong
Phone: 852-39745593 Fax: 852-35440462 info@eastlike.com www.eastlike.com



EASTLIKE LED COMPANY

Office Address:

Room B3, 18/F Bonsun Industrial Building,364-366
Sha Tsui Road, Tsuen Wan, Hong Kong

Tel: 852-3974 5593

Fax: 852-3544 0462

Whatsapp : 852 6756 7703

E-mail: info@eastlike.com

Website: www.eastlike.com